

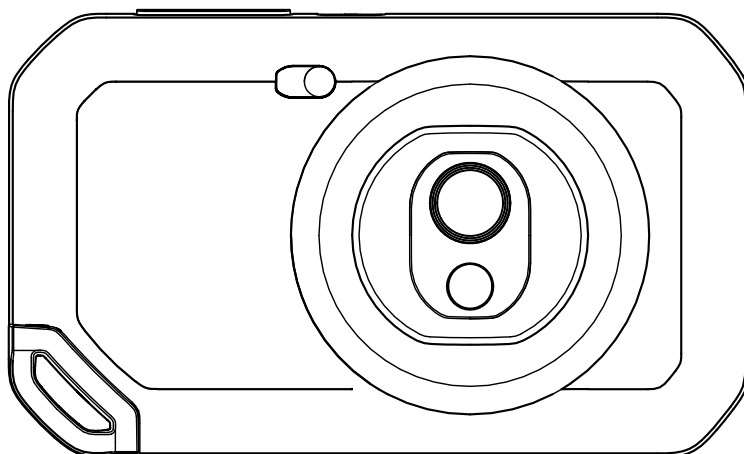

---

# User's manual FLIR Cx series



**Important note**

Before operating the device, you must read, understand, and follow all instructions, warnings, cautions, and legal disclaimers.

**Důležitá poznámka**

Před použitím zařízení si přečtěte veškeré pokyny, upozornění, varování a vyvázání se ze záruky, ujistěte se, že jim rozumíte, a řiďte se jimi.

**Viktig meddelelse**

Før du betjener enheden, skal du læse, forstå og følge alle anvisninger, advarsler, sikkerhedsforanstaltninger og ansvarsfraskrivelser.

**Wichtiger Hinweis**

Bevor Sie das Gerät in Betrieb nehmen, lesen, verstehen und befolgen Sie unbedingt alle Anweisungen, Warnungen, Vorsichtshinweise und Haftungsausschlüsse

**Σημαντική σημείωση**

Πριν από τη λειτουργία της συσκευής, πρέπει να διαβάσετε, να κατανοήσετε και να ακολουθήσετε όλες τις οδηγίες, προειδοποιήσεις, προφυλάξεις και νομικές αποποιήσεις.

**Nota importante**

Antes de usar el dispositivo, debe leer, comprender y seguir toda la información sobre instrucciones, advertencias, precauciones y renunciaciones de responsabilidad.

**Tärkeä huomautus**

Ennen laitteen käyttämistä on luettava ja ymmärrettävä kaikki ohjeet, vakavat varoitukset, varoitukset ja lakitiedotteet sekä noudatettava niitä.

**Remarque importante**

Avant d'utiliser l'appareil, vous devez lire, comprendre et suivre l'ensemble des instructions, avertissements, mises en garde et clauses légales de non-responsabilité.

**Fontos megjegyzés**

Az eszköz használatá elótt figyelmesen olvassa el és tartsa be az összes utasítást, figyelmeztetést, óvintézkedést és jogi nyilatkozatot.

**Nota importante**

Prima di utilizzare il dispositivo, è importante leggere, capire e seguire tutte le istruzioni, avvertenze, precauzioni ed esclusioni di responsabilità legali.

**重要な注意**

デバイスをご使用になる前に、あらゆる指示、警告、注意事項、および免責条項をお読み頂き、その内容を理解して従ってください。

**중요한 참고 사항**

장치를 작동하기 전에 반드시 다음의 사용 설명서와 경고, 주의사항, 법적 책임제한을 읽고 이해하며 따라야 합니다.

**Viktig**

Før du bruker enheten, må du lese, forstå og følge instruksjoner, advarsler og informasjon om ansvarsfraskrivelse.

**Belangrijke opmerking**

Zorg ervoor dat u, voordat u het apparaat gaat gebruiken, alle instructies, waarschuwingen en juridische informatie hebt doorgelezen en begrepen, en dat u deze opvolgt en in acht neemt.

**Ważna uwaga**

Przed rozpoczęciem korzystania z urządzenia należy koniecznie zapoznać się z wszystkimi instrukcjami, ostrzeżeniami, przestrogami i uwagami prawnymi. Należy zawsze postępować zgodnie z zaleceniami tam zawartymi.

**Nota importante**

Antes de utilizar o dispositivo, deverá proceder à leitura e compreensão de todos os avisos, precauções, instruções e isenções de responsabilidade legal e assegurar-se do seu cumprimento.

**Важное примечание**

До того, как пользоваться устройством, вам необходимо прочитать и понять все предупреждения, предостережения и юридические ограничения ответственности и следовать им.

**Viktig information**

Innan du använder enheten måste du läsa, förstå och följa alla anvisningar, varningar, försiktighetsåtgärder och ansvarsfriskrivningar.

**Önemli not**

Cihazı çalıştırmadan önce tüm talimatları, uyarıları, ikazları ve yasal açıklamaları okumalı, anlamalı ve bunlara uymalısınız.

**重要注意事項**

在操作设备之前，您必须阅读、理解并遵循所有说明、警告、注意事项和法律免责声明。

**重要注意事項**

操作裝置之前，您務必閱讀、了解並遵循所有說明、警告、注意事項與法律免責聲明。

# Table of contents

---

<b>1</b>	<b>Disclaimers</b> .....	<b>1</b>
1.1	Legal disclaimer .....	1
1.2	Export controls .....	1
1.3	Patents .....	1
1.4	Quality assurance .....	1
1.5	Third-party licenses .....	1
1.6	Usage statistics .....	1
1.7	Copyright .....	1
<b>2</b>	<b>Safety information</b> .....	<b>2</b>
2.1	Accessing regulatory information .....	3
<b>3</b>	<b>Notice to user</b> .....	<b>4</b>
3.1	Online documentation .....	4
3.2	Accuracy .....	4
3.3	Calibration .....	4
3.4	Training .....	4
3.5	Important note about this manual .....	4
3.6	Note about authoritative versions .....	4
3.7	Disposal of electronic waste .....	4
<b>4</b>	<b>Customer help</b> .....	<b>6</b>
4.1	General .....	6
4.2	Submitting a question .....	6
4.3	Downloads .....	6
<b>5</b>	<b>Quick start guide</b> .....	<b>7</b>
<b>6</b>	<b>Camera overview</b> .....	<b>8</b>
6.1	View from the front .....	8
6.2	View from the rear .....	8
6.3	Screen elements .....	9
6.3.1	General .....	9
6.3.2	Menu system .....	9
6.3.3	Status icons .....	9
6.3.4	Swipe-down menu .....	10
6.3.5	Overheat warning .....	10
<b>7</b>	<b>Achieving a good thermal image</b> .....	<b>11</b>
7.1	To keep in mind .....	11
7.2	Temperature scale .....	11
7.2.1	Example 1 .....	11
7.2.2	Example 2 .....	12
7.2.3	Manually adjusting the temperature scale .....	12
7.2.4	Locking the temperature scale .....	12
7.2.5	Showing/hiding the temperature scale .....	12
7.3	Temperature range .....	13
7.4	Image modes .....	13
7.4.1	General .....	13
7.4.2	Changing the image mode .....	13
7.4.3	Aligning the thermal and visual images .....	13
7.5	Color palettes .....	14
<b>8</b>	<b>Measuring temperatures</b> .....	<b>15</b>
8.1	Adding/removing measurement tools .....	15
8.2	Moving the spotmeter .....	15
8.3	Moving and resizing the box .....	15
8.4	Changing the measurement parameters .....	15
8.4.1	Setting measurement parameters .....	16
8.4.2	Recommended values .....	16
8.5	Color alarms and isotherms .....	16

## Table of contents

---

8.5.1	Set up a color alarm.....	17
<b>9</b>	<b>Saving and working with images .....</b>	<b>18</b>
9.1	Saving an image.....	18
9.2	Saving a high-resolution visual image.....	18
9.3	About image files.....	18
9.3.1	File-naming convention .....	18
9.4	Adding a note .....	18
9.5	Editing a saved image.....	19
9.6	Zooming and panning an image .....	19
<b>10</b>	<b>Uploading images .....</b>	<b>20</b>
10.1	Connecting to Wi-Fi.....	20
10.2	Pairing with FLIR Ignite.....	20
10.3	Automatic upload.....	20
10.4	Manual upload .....	20
10.4.1	Uploading an image.....	20
10.4.2	Uploading multiple images .....	21
10.4.3	Uploading a folder .....	21
10.5	FLIR Ignite .....	21
10.5.1	View images .....	21
10.5.2	Organize in folders .....	21
10.5.3	Search.....	21
10.5.4	Sync and download .....	21
10.5.5	Share and collaborate .....	21
<b>11</b>	<b>Working with the image gallery .....</b>	<b>23</b>
11.1	Opening a saved image.....	23
11.2	Creating a new folder.....	23
11.3	Renaming a folder.....	23
11.4	Changing the active folder .....	24
11.5	Moving files between folders .....	24
11.6	Deleting a folder .....	24
11.7	Deleting an image .....	24
11.8	Deleting multiple images .....	24
11.9	Deleting all images.....	24
<b>12</b>	<b>Streaming.....</b>	<b>26</b>
<b>13</b>	<b>Handling the camera.....</b>	<b>27</b>
13.1	Charging the battery.....	27
13.2	Turning on and turning off the camera.....	27
13.3	Using the camera lamp .....	27
13.4	Moving files via USB cable.....	27
13.4.1	Related topics .....	27
13.5	Bluetooth connection.....	27
13.6	Non-uniformity correction.....	28
13.7	Cleaning the camera .....	28
13.7.1	Camera housing, cables, and other items .....	28
13.7.2	Infrared lens.....	28
<b>14</b>	<b>Camera settings .....</b>	<b>30</b>
14.1	<i>Measurement parameters</i> .....	30
14.2	<i>Connections</i> .....	30
14.3	<i>Camera temperature range</i> .....	30
14.4	<i>Save options &amp; storage</i> .....	30
14.5	<i>Accounts</i> .....	30
14.6	<i>Device settings</i> .....	31
<b>15</b>	<b>Updating the camera.....</b>	<b>32</b>
15.1	Update the camera Over-The-Air (OTA) .....	32

## Table of contents

---

15.2	Update via USB cable with the FLIR Camera Updater .....	32
15.2.1	Install the FLIR Camera Updater.....	32
15.2.2	Connect the camera .....	32
15.2.3	Update notifications.....	32
<b>16</b>	<b>Declaration of conformity .....</b>	<b>33</b>

## 1.1 Legal disclaimer

For warranty terms, refer to <https://www.flir.com/warranty>.

## 1.2 Export controls

Products described herein may be subject to export regulations.

This document does not contain export-controlled information.

## 1.3 Patents

This product is protected by patents, design patents, patents pending, or design patents pending. Refer to the FLIR Systems' patent registry:

<https://www.flir.com/patentnotices>

## 1.4 Quality assurance

The Quality Management System under which these products are developed and manufactured has been certified in accordance with the ISO 9001 standard.

FLIR Systems is committed to a policy of continuous development; therefore we reserve the right to make changes and improvements on any of the products without prior notice.

## 1.5 Third-party licenses

Information about third-party licenses is available in the user interface of the product.

## 1.6 Usage statistics









FLIR Systems reserves the right to gather anonymous usage statistics to help maintain and improve the quality of our software and services.









## 1.7 Copyright

© 2025 FLIR Systems, Inc. All rights reserved worldwide. No parts of the software including source code may be reproduced, transmitted, transcribed or translated into any language or computer language in any form or by any means, electronic, magnetic, optical, manual or otherwise, without the prior written permission of FLIR Systems.

The documentation must not, in whole or part, be copied, photocopied, reproduced, translated or transmitted to any electronic medium or machine readable form without prior consent, in writing, from FLIR Systems.

Names and marks appearing on the products herein are either registered trademarks or trademarks of FLIR Systems and/or its subsidiaries. All other trademarks, trade names or company names referenced herein are used for identification only and are the property of their respective owners.

 <b>WARNING</b>
<p><b>Applicability:</b> Class B digital devices.</p> <p>This equipment has been tested and found to comply with the limits for a Class B digital device, pursuant to Part 15 of the FCC Rules. These limits are designed to provide reasonable protection against harmful interference in a residential installation. This equipment generates, uses and can radiate radio frequency energy and, if not installed and used in accordance with the instructions, may cause harmful interference to radio communications. However, there is no guarantee that interference will not occur in a particular installation. If this equipment does cause harmful interference to radio or television reception, which can be determined by turning the equipment off and on, the user is encouraged to try to correct the interference by one or more of the following measures:</p> <ul style="list-style-type: none"> <li>• Reorient or relocate the receiving antenna.</li> <li>• Increase the separation between the equipment and receiver.</li> <li>• Connect the equipment into an outlet on a circuit different from that to which the receiver is connected.</li> <li>• Consult the dealer or an experienced radio/TV technician for help.</li> </ul>
 <b>WARNING</b>
<p><b>Applicability:</b> Digital devices subject to 15.19/RSS-GEN.</p> <p><b>NOTICE:</b> This device complies with Part 15 of the FCC Rules and with Industry Canada licence-exempt RSS standard(s). Operation is subject to the following two conditions:</p> <ol style="list-style-type: none"> <li>1. this device may not cause harmful interference, and</li> <li>2. this device must accept any interference received, including interference that may cause undesired operation.</li> </ol>
 <b>WARNING</b>
<p><b>Applicability:</b> Digital devices subject to 15.21.</p> <p><b>NOTICE:</b> Changes or modifications made to this equipment not expressly approved by FLIR Systems may void the FCC authorization to operate this equipment.</p>
 <b>WARNING</b>
<p><b>Applicability:</b> Digital devices subject to 2.1091/2.1093/KDB 447498/RSS-102.</p> <p><b>Radiofrequency radiation exposure Information:</b> For body worn operation, this device has been tested touched to the phantom and meets FCC RF exposure guidelines. Nevertheless, the device should be used in such a manner that the potential for human contact during normal operation is minimized.</p>
 <b>WARNING</b>
<p>This device is granted pursuant to the Japanese Radio Law (電波法) and the Japanese Telecommunications Business Law (電気通信事業法). This device should not be modified (otherwise the granted designation number will become invalid)</p>
 <b>WARNING</b>
<p>Do not disassemble or do a modification to the battery. The battery contains safety and protection devices which, if damage occurs, can cause the battery to become hot, or cause an explosion or an ignition.</p>
 <b>WARNING</b>
<p>Make sure that you read all applicable MSDS (Material Safety Data Sheets) and warning labels on containers before you use a liquid. The liquids can be dangerous. Injury to persons can occur.</p>
 <b>CAUTION</b>
<p>Do not point the infrared camera (with or without the lens cover) at strong energy sources, for example, devices that cause laser radiation, or the sun. This can have an unwanted effect on the accuracy of the camera. It can also cause damage to the detector in the camera.</p>

	<b>CAUTION</b>
Do not use the camera in temperatures more than 50°C (122°F), unless other information is specified in the user documentation or technical data. High temperatures can cause damage to the camera.	
	<b>CAUTION</b>
Do not attach the batteries directly to a car's cigarette lighter socket, unless FLIR Systems supplies a specific adapter to connect the batteries to a cigarette lighter socket. Damage to the batteries can occur.	
	<b>CAUTION</b>
Do not use the battery if, when you use, charge, or put the battery in storage, there is an unusual smell from the battery, the battery feels hot, changes color, changes shape, or is in an unusual condition. Speak with your sales office if one or more of these problems occurs. Damage to the battery and injury to persons can occur.	
	<b>CAUTION</b>
The temperature range through which you can charge the battery is ±0°C to +35°C (+32°F to +95°F), except for the Korean market where the approved range is +10°C to +35°C (+50°F to +95°F). If you charge the battery at temperatures out of this range, it can cause the battery to become hot or to break. It can also decrease the performance or the life cycle of the battery.	
	<b>CAUTION</b>
The temperature range through which you can remove the electrical power from the battery is -10°C to +50°C (+14°F to +122°F), unless other information is specified in the user documentation or technical data. If you operate the battery out of this temperature range, it can decrease the performance or the life cycle of the battery.	
	<b>CAUTION</b>
Do not apply solvents or equivalent liquids to the camera, the cables, or other items. Damage to the battery and injury to persons can occur.	
	<b>CAUTION</b>
Be careful when you clean the infrared lens. The lens has an anti-reflective coating which is easily damaged. Damage to the infrared lens can occur.	
	<b>CAUTION</b>
Do not use too much force to clean the infrared lens. This can cause damage to the anti-reflective coating.	
	<b>CAUTION</b>
The 5 GHz band is only allowed for indoor use in Japan and Canada.	

## 2.1 Accessing regulatory information

To access the regulatory information available in the camera, tap  (*Settings*) > *Device settings* > *Camera information* > *Regulatory*.

## 3.1 Online documentation

Our manuals are continuously updated and published online.

To access the FLIR Cx series user manual and other product documentation, go to <http://support.flir.com/resources/cx>.



To access the manuals for our other products, as well as manuals for our discontinued products, go to <https://support.flir.com/resources/app>.

## 3.2 Accuracy

For very accurate results, we recommend that you wait 5 minutes after you have started the camera before measuring a temperature.

## 3.3 Calibration

We recommend that you send in the camera for calibration once a year. Contact your local sales office or contact our Technical Support Center at <https://www.flir.com/support> for instructions on where to send the camera.

## 3.4 Training

For training resources and courses, go to <https://www.flir.com/support-center/training>.

## 3.5 Important note about this manual

FLIR Systems issues generic manuals that cover several cameras within a model line.

This means that this manual may contain descriptions and explanations that do not apply to your particular camera model.

## 3.6 Note about authoritative versions

The authoritative version of this publication is English. In the event of divergences due to translation errors, the English text has precedence. Any late changes are first implemented in English.

## 3.7 Disposal of electronic waste

Electrical and electronic equipment (EEE) contains materials, components and substances that may be hazardous and present a risk to human health and the environment when waste electrical and electronic equipment (WEEE) is not handled correctly.

Equipment marked with the below crossed-out wheeled bin is electrical and electronic equipment. The crossed-out wheeled bin symbol indicates that waste electrical and electronic equipment should not be discarded together with unseparated household waste, but must be collected separately.

For this purpose all local authorities have established collection schemes under which residents can dispose waste electrical and electronic equipment at a recycling centre or other collection points, or WEEE will be collected directly from households. More detailed information is available from the technical administration of the relevant local authority.



## 4.1 General

Do not hesitate to contact our Customer Support Center if you experience problems or have any questions.

For customer help, go to <http://support.flir.com>.

## 4.2 Submitting a question

To submit a question to the customer help team, you must be a registered user. It only takes a few minutes to register online. If you only want to search the knowledgebase for existing questions and answers, you do not need to be a registered user.

When you want to submit a question, make sure that you have the following information to hand:

- The camera model.
- The camera serial number.
- The communication protocol, or method, between the camera and your device (e.g., SD card reader, HDMI, Ethernet, USB, or FireWire).
- Device type (PC/Mac/iPhone/iPad/Android device, etc.).
- Version of any programs from FLIR Systems.
- Full name, publication number, and revision number of the manual.

## 4.3 Downloads

On the customer help site you can also download the following, when applicable for the product:

- Firmware updates for your infrared camera.
- Program updates for your PC/Mac software.
- Freeware and evaluation versions of PC/Mac software.
- User documentation for current, obsolete, and historical products.
- Mechanical drawings (in \*.dxf and \*.pdf format).
- CAD data models (in \*.stp format).
- Application examples.
- Technical datasheets.

1. Push the On/off button  to turn on the camera.
2. Follow the instructions on the camera screen to select the language, units, date and time formats, etc.
3. You can easily set up the camera to upload images for storage online.

To enable upload of images, you need to connect your camera to a FLIR Ignite account. Use a computer or other device with internet access and follow the instructions on the camera screen.

4. To enable automatic upload of images, select  (*Settings*), sign in to FLIR Ignite, and set the *Auto upload* switch to *On*.
5. To save an image, push the *Save* button.
6. If automatic upload is enabled, new images will automatically be uploaded to your FLIR Ignite account when the camera is connected to the internet.

You can also upload images manually or move images from the camera using the USB cable.

7. To access your FLIR Ignite account, go to <https://ignite.flir.com>.

## 6.1 View from the front

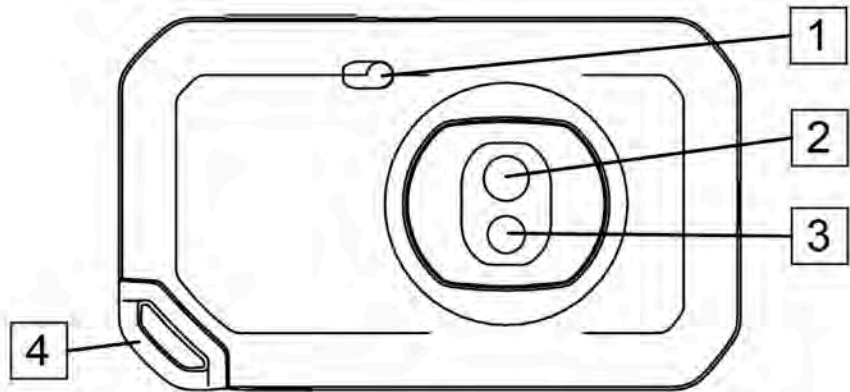

1. Camera lamp.
2. Infrared lens.
3. Visual camera lens.
4. Lanyard attachment point.

## 6.2 View from the rear

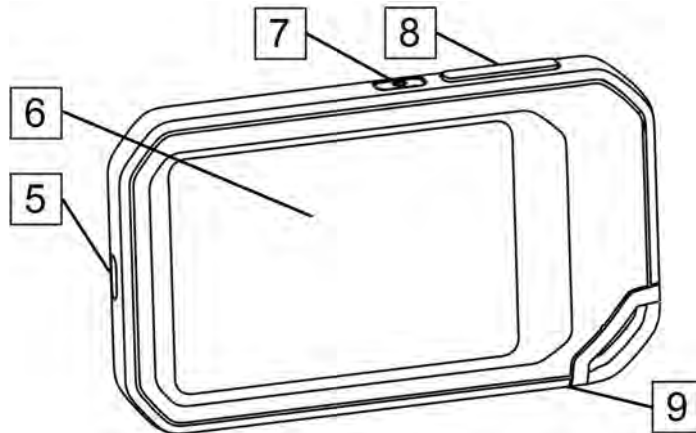

5. USB-C connector.
6. Camera screen.
7. On/off button.
8. Save button.
9. Tripod mount.

## 6.3 Screen elements

### 6.3.1 General

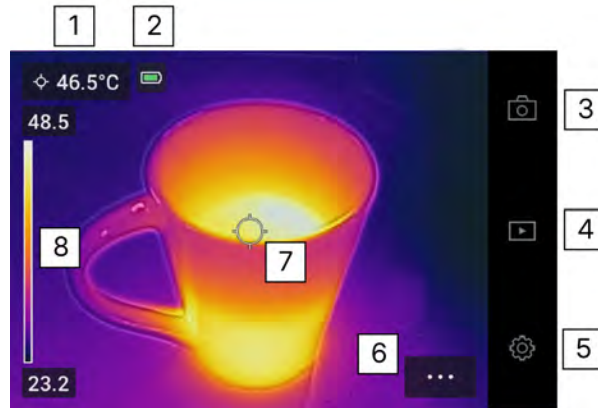

1. Result table.
2. Status icons.
3. Live view button.
4. Gallery button.
5. Settings button.
6. Menu button.
7. Spotmeter.
8. Temperature scale.



### 6.3.2 Menu system

To display the menu system, tap the menu button



1. Main menu toolbar.
2. Submenu toolbar.

### 6.3.3 Status icons

	Battery status indicator. <ul style="list-style-type: none"> <li>• When the battery status is 20–100%, the indicator is white.</li> <li>• When the battery is charging, the indicator is green.</li> <li>• When the battery status is below 20%, the indicator is red.</li> </ul>
	The remaining storage capacity of the camera memory is below 100 MB.

### 6.3.4 Swipe-down menu

To open the swipe-down menu, place your finger at the top of the screen and swipe down.



1. Battery status indicator.

2. Control buttons:

- *Wi-Fi* button: Tap to enable/disable Wi-Fi. See also section 10.1 *Connecting to Wi-Fi*, page 20.
- *Bluetooth* button: Tap to enable/disable Bluetooth. See also section 13.5 *Bluetooth connection*, page 27.
- *Upload* button: Tap to enable/disable automatic upload of images. See also section 10.3 *Automatic upload*, page 20.
- *Lamp* button: Tap to turn on/off the camera lamp.

3. Screen brightness slider: Used to control the brightness of the screen.

4. Camera memory indicator.

5. The FLIR Ignite user account that the camera is paired with. For more information, see section 10.2 *Pairing with FLIR Ignite*, page 20.

### 6.3.5 Overheat warning

For battery safety, a warning will show if it gets too hot:

1. An indicator provides a visual warning to the user that the thermal imager is about to shut down due to the internal overheating.
2. If the camera continues to be on, a message will show on the screen and the camera will shut down automatically.

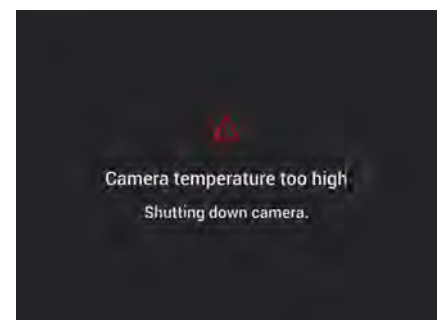
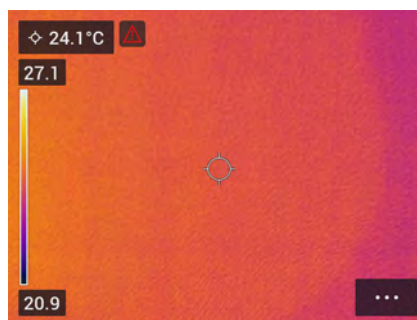

These are the functions and settings you need to experiment with to achieve a good thermal image:

- Adjusting the temperature scale.
- Selecting a suitable temperature range.
- Selecting a suitable image mode.
- Changing the color palette.

## 7.1 To keep in mind

- A thermal camera has a resolution limit. This depends on the size of the detector, the lens, and the distance to the target. Use the center of the spot tool as a guide to the minimum possible object size, and get closer if necessary. Make sure to stay away from dangerous areas and live electrical components.
- Be careful when holding the camera perpendicular to the target. Be observant of reflections, especially at low emissivities—you, the camera, or the surroundings may become the main source of reflection.
- Select a zone of high emissivity, e.g., an area with a matte surface, to perform a measurement.
- Blank objects, i.e., those with low emissivities, may appear warm or cold in the camera, because they mainly reflect the environment.
- Avoid direct sunlight on the details that you are inspecting.
- Various types of faults, e.g., those in a building's construction, may result in the same type of thermal pattern.
- Correctly analyzing an infrared image requires professional knowledge about the application.

## 7.2 Temperature scale

An infrared image can be adjusted automatically or manually.

In automatic mode, the camera continuously adjusts the level and span for the best image presentation. The temperature scale on the screen shows the upper and lower temperatures of the current span.

In manual mode, you can adjust the temperature scale to values close to the temperature of a specific object in the image. This will make it possible to detect anomalies and smaller temperature differences in the part of the image of interest.

### 7.2.1 Example 1

Here are two infrared images of a building. In the left image, which is auto-adjusted, the large temperature span between the clear sky and the heated building makes a correct analysis difficult. You can analyze the building in more detail if you change the temperature scale to values close to the temperature of the building.



Automatic



Manual

### 7.2.2 Example 2

Here are two infrared images of an isolator in a power line. To make it easier to analyze the temperature variations in the isolator, the temperature scale in the right image has been changed to values close to the temperature of the isolator.

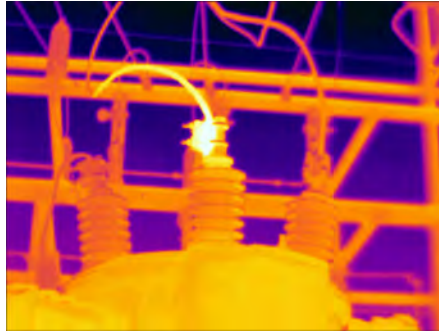



Automatic



Manual

### 7.2.3 Manually adjusting the temperature scale

1. Tap the menu button .
2. Tap *Temperature scale*  and then tap *Manual* . This displays a wheel next to the temperature scale.
3. To enhance the details of a certain point of interest in the image, tap that point on the screen. The image will be auto-adjusted based on the thermal content of the area around the tapped point.
4. To change the level, scroll the wheel up/down.
5. To change the span, do the following:
  - 5.1. Tap the temperature limit you want to keep unchanged. This locks the limit.
  - 5.2. Scroll the wheel up/down to change the value of the other temperature limit.

### 7.2.4 Locking the temperature scale

You can lock the temperature scale.

- To lock the temperature scale, tap the upper and the lower temperature limits.
- To unlock the temperature scale, tap the temperature limits again.

#### Note

- When a temperature limit (upper and/or lower) is locked, the auto-adjust by touch function is disabled.
- If you switch to automatic mode, the temperature scale will automatically unlock.

A typical situation where you would lock the temperature scale is when looking for temperature anomalies in two items with a similar design or construction.

For example, you have two cables, and you suspect that one is overheated. With the camera in automatic mode, direct the camera toward the cable that has a normal temperature. Then activate the manual mode and lock the temperature scale.

When you direct the camera, with the temperature scale locked, toward the suspected overheated cable, that cable will appear in a *lighter* color in the thermal image if its temperature is *higher* than the first cable.

If you instead use the automatic mode, the color for the two items might appear the same despite their temperature being different.

### 7.2.5 Showing/hiding the temperature scale

In some situations, you may want to hide the temperature scale for a better view.

- 
1. Tap the *Settings* button .
  2. Tap *Device settings* > *Show temperature scale*.
  3. Show/hide the temperature scale by toggling the *Show temperature scale* switch.

## 7.3 Temperature range

The camera is calibrated for different temperature ranges. For accurate temperature measurements, you must change the *Camera temperature range* setting to suit the expected temperature of the object you are inspecting.

To change the temperature range, do the following:

1. Tap the *Settings* button .
2. Tap *Camera temperature range*.
3. Select the appropriate temperature range.

## 7.4 Image modes

### 7.4.1 General

The camera can capture thermal and visual images at the same time. By choosing the image mode, you select which type of image to display on the screen.

The camera supports the following image modes:

- *Thermal MSX* (Multi Spectral Dynamic Imaging): An infrared image where the edges of the objects are enhanced with visual image details is displayed.
- *Thermal*: An infrared image is displayed.
- *Digital camera*: The visual image captured by the digital camera is displayed.
- *Picture in picture*: An infrared image frame is displayed on top of the visual image.

#### Note

- For the *Thermal MSX*, *Thermal*, and *Picture in picture* image modes, all thermal and visual information is stored when an image is saved. This means that you can edit the image later, in the camera image gallery or in a FLIR Thermography software, and select any of the image modes.
- For the *Digital camera* image mode, a visual image is stored when an image is saved. However, no thermal information is stored.
- You can choose to turn off the digital camera. This can, for example, be required in restricted areas. Select  (*Settings*) > *Save options & storage* > *Digital camera = Off*. When the digital camera is off, only the image mode *Thermal* is enabled.

### 7.4.2 Changing the image mode

To change the image mode, do the following:

1. Tap the menu button .
2. Tap *Image mode* .
3. Tap the image mode you want to use.

### 7.4.3 Aligning the thermal and visual images

In *Thermal MSX* and *Picture in picture* modes, the camera displays a combination of thermal and visual images. When looking at an object close up or far away, you may need to adjust the distance setting in the camera to align the thermal and visual images.

To align the thermal and visual images, do the following:

1. Tap the screen. This displays a box with a distance in the upper right corner.

2. Tap the distance box. This displays a slider.
3. Use the slider to adjust the distance.

## 7.5 Color palettes

You can change the color palette that the camera uses to display different temperatures. Changing the palette can make it easier to analyze an image.

To change the color palette, do the following:

1. Tap the menu button .
2. Tap *Color* .
3. Tap the palette you want to use.



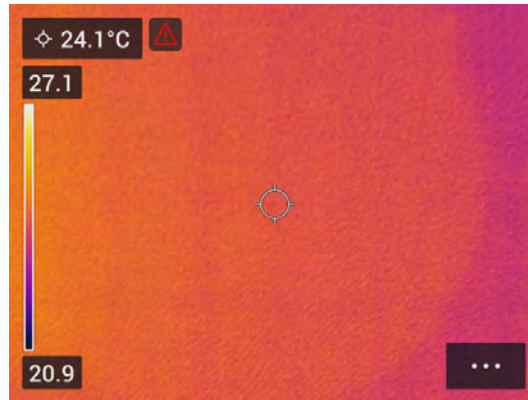

You can measure a temperature using a spotmeter or a box. The measured temperatures are displayed in the result table on the screen.

- With a spotmeter, the camera measures the temperature at the position of the spotmeter.
- With a box, the camera detects the hottest/coldest spot within the box area and measures its temperature.



**Note** For accurate temperature measurements, you may need to change the measurement parameters. See section 8.4 *Changing the measurement parameters*, page 15.

## 8.1 Adding/removing measurement tools

1. Tap the menu button .
2. Tap *Measurement* .
3. Do one or more of the following:
  - Tap  to add/remove a spotmeter.
  - Tap  to add/remove a hot spot box.
  - Tap  to add/remove a cold spot box.

## 8.2 Moving the spotmeter

1. Tap the spotmeter. The tool is now displayed with a handle.
2. Tap and hold the spotmeter and drag it to a new position..

## 8.3 Moving and resizing the box

1. Tap one of the corners of the box. The tool is now displayed with handles.
2. To move the box, tap and hold the center handle and drag the box to a new position.
3. To resize the box, tap and hold one of the corner handles and drag it to a new position.

## 8.4 Changing the measurement parameters

For accurate temperature measurements, it is important to use appropriate measurement parameters:

- *Emissivity*: The emissivity determines how much of the radiation originates from the object as opposed to being reflected by it.
- *Reflected temperature*: This parameter is used to compensate for the radiation from the surroundings reflected by the object into the camera.
- *Relative humidity*: The relative humidity of the air between the camera and the object of interest.
- *Atmospheric temperature*: The temperature of the air between the camera and the object of interest.
- *Distance*: The distance between the camera and the object of interest.

**Note** During normal operation there is typically no need to change the default measurement parameters, see section 8.4.2 *Recommended values*, page 16.

#### 8.4.1 Setting measurement parameters

*Emissivity* is the most important measurement parameter to set correctly. If the *Emissivity* is set to a low value, the *Reflected temperature* also becomes important. The parameters *Relative humidity*, *Atmospheric temperature*, and *Distance* are relevant for longer distances.

To set the measurement parameters, do the following:

1. Tap the *Settings* button .
2. Tap *Measurement parameters*.
3. Tap the measurement parameter you want to change.
4. Select the appropriate parameter setting.

#### 8.4.2 Recommended values

If you are unsure about the measurement parameter values, the following are recommended:

Emissivity	0.95
Reflected temperature	20°C (69°F)
Relative humidity	50%
Atmospheric temperature	20°C (69°F)
Distance	1 m (3.3 ft.)

## 8.5 Color alarms and isotherms

**Note** Color alarms does not apply for C3-X and C5.

By using color alarms (isotherms), anomalies can easily be discovered in an infrared image. The isotherm command applies a contrasting color to all pixels with a temperature above or below the specified temperature level.



*Above alarm*: Highlights all pixels with a temperature above the specified temperature level.



*Below alarm*: Highlights all pixels with a temperature below the specified temperature level.

### 8.5.1 Set up a color alarm

On the main toolbar, select *Color*. This displays a toolbar where you can select the *Above alarm* or *Below alarm*.

The threshold temperature is displayed in the upper right corner of the live image.

To change the threshold temperature, push the navigation pad up/down. To lock/unlock the setting, tap the threshold temperature button. The button background is black when the setting is locked and white when unlocked.

## 9.1 Saving an image

To save an image, push the Save button at the top of the camera.

When you save an image, the camera stores the image file in the camera memory. You can also set up the camera to upload images for storage online, see section 10 *Uploading images*, page 20.

## 9.2 Saving a high-resolution visual image

Select the *Digital camera* image mode to save a high-resolution visual image (5 megapixel image). Note that no thermal information is stored when in this image mode.

## 9.3 About image files

When an image is saved in one of the image modes *Thermal MSX*, *Thermal*, or *Picture in picture*, the saved image file contains all thermal and visual information. This means that you can open an image file, in the camera or in a FLIR Thermography software, and, for example, change the color palette, apply another image mode, and add measurement tools.

When an image is saved in the *Digital camera* image mode, a 5 megapixel image containing only the visual information is saved.

### 9.3.1 File-naming convention

The naming convention for image files is *FLIRxxxx.jpg*, where *xxxx* is a unique counter.

To reset the numbering of the image filenames, tap  (*Settings*) > *Device settings* > *Reset options* > *Reset image counter...* > *Reset*.



**Note** To prevent image files being overwritten, the new counter value will be based on the highest existing filename number in the camera memory. To ensure that the counter is reset to 0001, delete all images from the camera memory before resetting the counter.

## 9.4 Adding a note







To make reporting and post-processing more efficient, you can add notes with additional information, e.g., conditions and information about where an image is taken. The notes are added to the image file and can be viewed and edited in the camera or in a FLIR Thermography software.

You can set up the camera to automatically prompt for a note when an image has been saved. Select  (*Settings*) > *Save options & storage* > *Add note after saving* = *On*.

You can also add notes to saved images in the image gallery, by doing the following:

1. Tap the *Gallery* button .
2. Tap a folder and then tap an image.
3. Tap  and then tap *Note*.
4. A soft keyboard is displayed, where you can enter text.
5. When completed, tap *Done* on the soft keyboard.
6. To get the note stored online, make a manual upload of the image. See section 10.4 *Manual upload*.

## 9.5 Editing a saved image

1. Tap the *Gallery* button .
2. Tap a folder and then tap an image.
3. Tap  and then tap *Edit*. This opens the image in edit mode.
4. Manual adjustment mode is now active. For adjustment instructions, see section 7.2.3 *Manually adjusting the temperature scale*, page 12.
5. Tap the menu button .
  - To change the image mode, tap *Image mode* .
  - To add a measurement tool, tap *Measurement* .
  - To change the color palette, tap *Color* .
6. To exit edit mode, tap .
7. To get the edited image stored online, make a manual upload of the image. See section 10.4 *Manual upload*.

## 9.6 Zooming and panning an image

You can zoom an image by using the camera's digital zoom function. You can do this on live images and on saved images in edit mode. While zooming in edit mode, you can also pan the image.

The digital zoom factor is temporarily displayed in the center of the screen.

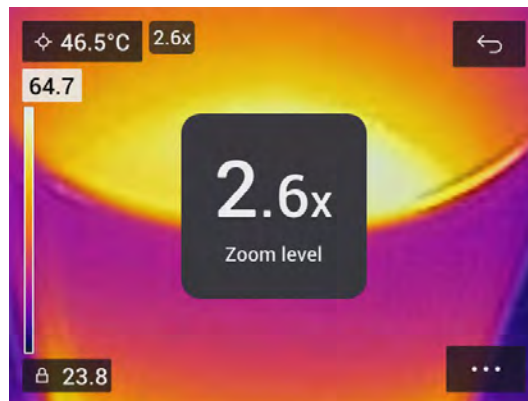

To digitally zoom and pan an image, do the following:

- Zoom in: Touch the screen with two fingers and spread the fingers apart.
- Zoom out: Touch the screen with two fingers and pinch the fingers together.
- Pan: While in edit mode and after zooming in, touch the screen with one finger and move the finger.

You can set up the camera to upload images for storage online.

To enable upload of images, you need to connect the camera to a Wi-Fi network and pair the camera with a FLIR Ignite account.

If automatic upload is enabled, new images will automatically be uploaded to your FLIR Ignite account when the camera is connected to a Wi-Fi network. You can also upload images manually.

## 10.1 Connecting to Wi-Fi

1. Tap the *Settings* button .
2. Tap *Connections > Wi-Fi*.
3. Make sure Wi-Fi is enabled by toggling the *Wi-Fi* switch.

When Wi-Fi is enabled, a list of the available networks is displayed.

4. In the list, tap one of the networks.

**Note** Password-protected networks are indicated with a padlock icon, and for these you will need to enter a password the first time you connect to the network. After that the camera will connect automatically to the network. To disable the automatic connection, select the currently connected network and then select *Forget network*.

## 10.2 Pairing with FLIR Ignite

You can pair the camera as part of the initial setup of the camera. You can also pair the camera at any time via the *Settings* menu.

1. Make sure the camera is connected to the internet.
2. Tap the *Settings* button .
3. Tap *FLIR Ignite*.
4. Start the pairing procedure by tapping *Sign in*.
5. Use a computer or other device with internet access and go to the website displayed on the camera screen.
6. On the website, enter the code displayed on the camera screen.
7. Sign in to your FLIR Ignite account.

## 10.3 Automatic upload

You can set up the camera to automatically upload images to your FLIR Ignite account when the camera is connected to the internet.

To enable automatic upload of images, do the following:

1. Tap the *Settings* button .
2. Tap *Save options & storage > Auto upload*.
3. Enable/disable automatic upload by toggling the *Auto upload* switch.

## 10.4 Manual upload



You can manually upload images to your FLIR Ignite account when the camera is connected to the internet.

### 10.4.1 Uploading an image



1. Make sure the camera is connected to a Wi-Fi network.
2. Tap the *Gallery* button .

3. Tap a folder and then tap an image.
4. Tap  and then tap *Upload*.

#### 10.4.2 Uploading multiple images

1. Make sure the camera is connected to a Wi-Fi network.
2. Tap the *Gallery* button .
3. Tap a folder.
4. Tap  and then tap the images you want to upload.
5. Tap .

#### 10.4.3 Uploading a folder

1. Make sure the camera is connected to a Wi-Fi network.
2. Tap the *Gallery* button .
3. Tap a folder.
4. Tap  and then tap *Upload*.

## 10.5 FLIR Ignite

In FLIR Ignite, you can view, organize, search for, download, and share your uploaded images.

To access your FLIR Ignite account, go to <https://ignite.flir.com>.

#### 10.5.1 View images

In FLIR Ignite, you can view all images uploaded from your camera. You can see measurement functions in the image, read notes, zoom in to see more details, and switch between thermal and visual images.

#### 10.5.2 Organize in folders

Folders that you create in your camera will also be created in FLIR Ignite. Images saved in the folders on your camera will be uploaded to the corresponding folder in your FLIR Ignite Library.

To create a suitable structure for your thermal images, you can create additional folders in FLIR Ignite and move the folders created in your camera into those.

#### 10.5.3 Search

You can search among all your files and images uploaded to FLIR Ignite. It is possible to search on file names, folder names, and any notes added to the images.

#### 10.5.4 Sync and download

With FLIR Ignite Sync your image library is automatically synced with your computer, allowing you to easily analyze and create reports in a FLIR Thermography software. You can add or rename images and all changes will instantly be synced across all your devices.

You can select one or more images for download to your computer. Folders and selections of multiple files are downloaded as .zip files.

#### 10.5.5 Share and collaborate



You can share results with colleagues and clients by generating a shared link. You can share individual images and entire folders. Shared links can be password protected and you can set an expiry date.

You can invite team members to edit or view a folder. The collaborators simply sign in to their FLIR Ignite account, accept the invitation, and can then start working directly in the folder.

When you save an image, the camera stores the image file in the image gallery of the camera. You can open an image in the image gallery and, for example, change the color palette, apply another image mode, and add measurement tools.

The image gallery can include one or several folders. New images will be saved to the active folder. You can create new folders, rename a folder, change the active folder, move files between the folders, and delete folders.



## 11.1 Opening a saved image

1. Tap the *Gallery* button . This displays the *Gallery* with one or more folders.
2. Tap a folder.
3. Tap the image you want to view. This displays thumbnails of the thermal and visual images and information about the image.
4. To view an image in full screen, tap .

To return to the thumbnail view, tap .

5. To do changes to the image, tap . This displays a menu where you can do one or more of the following:
  - Upload the image. For more information, see section 10.4 *Manual upload*, page 20.
  - Edit the image. For more information, see section 9.5 *Editing a saved image*, page 19.
  - Move the image to another folder in the image gallery.
  - Add a note. For more information, see section 9.4 *Adding a note*, page 18.
  - Delete the image.



## 11.2 Creating a new folder

1. Tap the *Gallery* button .
2. Tap .
3. A soft keyboard is displayed, where you can enter the name of the new folder.
4. When completed, tap *Done* on the soft keyboard.
5. The new folder automatically becomes the active folder and appears at the top of the *Gallery*.

## 11.3 Renaming a folder

You can change the name of the folders in the image gallery. The active folder cannot be renamed.

To rename a folder, do the following:

1. Tap the *Gallery* button .
2. Tap the folder to rename.
3. Tap  and then tap *Rename*.
4. A soft keyboard is displayed, where you can enter the new name of the folder.
5. When completed, tap *Done* on the soft keyboard.



## 11.4 Changing the active folder

New images are saved to the active folder.

To change the active folder, do the following:

1. Tap the *Gallery* button .
2. Tap the folder that new images should be saved to.
3. Tap **⋮** and then tap *Save new images to this folder*.
4. The new active folder is now at the top of the *Gallery*.

## 11.5 Moving files between folders

1. Tap the *Gallery* button .
2. Tap a folder.
3. Tap  and then tap the images you want to move.
4. Tap  and then tap the destination folder.

## 11.6 Deleting a folder

You can delete a folder in the image gallery. The active folder cannot be deleted.



To delete a folder, do the following:

1. Tap the *Gallery* button .
2. Tap a folder.
3. Tap **⋮** and then tap *Delete*. This displays a dialog box.
4. To delete the folder and the images, tap *Delete*.

## 11.7 Deleting an image

1. Tap the *Gallery* button .
2. Tap a folder and then tap an image.
3. Tap **⋮** and then tap *Delete*. This displays a dialog box.
4. To delete the image, tap *Delete*.

## 11.8 Deleting multiple images

1. Tap the *Gallery* button .
2. Tap a folder.
3. Tap  and then tap the images you want to delete.
4. Tap . This displays a dialog box.
5. To delete the selected images, tap *Delete*.

## 11.9 Deleting all images

You can delete all images from the camera memory.

To delete all images, do the following:

1. Tap the *Settings* button .
2. Tap *Save options & storage* and then tap *Delete all saved files....* This displays a dialog box.
3. To permanently delete all images, tap *Delete*.

**Note** The C3-X does not support video streaming.

The camera can stream what is currently visible on the screen to a computer via USB, just as a connected web camera. Use FLIR Thermography software or a third party web camera software to display the image stream on the computer screen.

To stream images from the camera to a computer, do the following:

1. Connect the camera to the computer using a USB cable.
2. Tap  (*Settings*) > *Device settings*.
3. Ensure that *Enable USB streaming* = *On*.
4. Start the streaming application on your computer and follow the instructions.



## 13.1 Charging the battery

You can charge the battery by using a standard USB power adapter or by connecting the camera to a computer.

It is good practice to disconnect the camera from power when the battery is fully charged.

The battery status is displayed on the swipe-down menu, see section 6.3.4 *Swipe-down menu*, page 10.

## 13.2 Turning on and turning off the camera

- When the camera is off, push and hold the On/off button  for about 2 seconds to turn on the camera.
- When the camera is on and in live mode, push and hold the On/off button  for about 1 second until the screen goes black. This puts the camera in standby mode. From standby, the camera automatically turns off after 48 hours.
- When the camera is on, push and hold the On/off button  for about 4 seconds to turn off the camera (from software version 2.2.17 and later).

You can also set up the camera to enter standby mode after a period of inactivity. Select

 (*Settings*) > *Device settings* > *Auto power off*.

## 13.3 Using the camera lamp

You control the camera lamp on the swipe-down menu, see section 6.3.4 *Swipe-down menu*, page 10.

## 13.4 Moving files via USB cable

When you save an image, the file is stored in the internal camera memory. You can move the image files by connecting the camera to a computer using the USB cable. The file transfer is done using the Media Transfer Protocol (MTP).

**Note** To be able to access the camera file system from a Mac computer, you must first install an Android File Transfer application. For more information, go to <https://www.android.com/filetransfer>.

To move files to a computer via USB cable, do the following:

1. Turn on the camera.
2. Connect the camera to the computer using the USB cable.
3. Move the files to the computer using a drag-and-drop operation.

**Note** Moving a file using a drag-and-drop operation does not delete the file in the camera.

### 13.4.1 Related topics

You can also set up the camera to upload images for storage online, see section 10 *Uploading images*, page 20.

## 13.5 Bluetooth connection

If supported by your mobile phone, you can share the phone's internet connection with the camera via Bluetooth. Before you can use the internet sharing connection, you need to pair the devices.

1. Tap the *Settings* button .
2. Tap *Connections > Bluetooth*.
3. Make sure Bluetooth is enabled by toggling the *Bluetooth* switch.

**Note** On the mobile phone, you must also make sure that Bluetooth is enabled, that the phone is in discovery mode, and that Bluetooth tethering is enabled.

4. Tap *Available devices*.
5. Wait until a list of available Bluetooth devices is displayed.
6. In the list, tap your mobile phone to begin the pairing procedure.

## 13.6 Non-uniformity correction

When the thermal camera displays *Calibrating...* it is performing what in thermography is called a "non-uniformity correction" (NUC). An NUC is *an image correction carried out by the camera software to compensate for different sensitivities of detector elements and other optical and geometrical disturbances*<sup>1</sup>

The camera performs the NUC automatically, for example at start-up and when the environment temperature changes.

To perform an NUC manually, tap and hold the  button.

## 13.7 Cleaning the camera

### 13.7.1 Camera housing, cables, and other items

Use one of these liquids:

- Warm water
- A weak detergent solution

Equipment:

- A soft cloth

Follow this procedure:

1. Soak the cloth in the liquid.
2. Twist the cloth to remove excess liquid.
3. Clean the part with the cloth.

	<b>CAUTION</b>
Do not apply solvents or similar liquids to the camera, the cables, or other items. This can cause damage.	

### 13.7.2 Infrared lens

Use one of these liquids:

- A commercial lens cleaning liquid with more than 30% isopropyl alcohol.
- 96% ethyl alcohol (C<sub>2</sub>H<sub>5</sub>OH).

Equipment:

- Cotton wool

1. Definition from the European standard EN 16714-3:2016, Non-destructive Testing—Thermographic Testing—Part 3: Terms and Definitions.

**CAUTION**

If you use a lens cleaning cloth it must be dry. Do not use a lens cleaning cloth with the liquids that are listed above. These liquids can cause material on the lens cleaning cloth to become loose. This material can have an unwanted effect on the surface of the lens.

Follow this procedure:

1. Soak the cotton wool in the liquid.
2. Twist the cotton wool to remove excess liquid.
3. Clean the lens one time only and discard the cotton wool.

**WARNING**

Make sure that you read all applicable MSDS (Material Safety Data Sheets) and warning labels on containers before you use a liquid: the liquids can be dangerous.

**CAUTION**

- Be careful when you clean the infrared lens. The lens has a delicate anti-reflective coating.
- Do not clean the infrared lens too vigorously. This can damage the anti-reflective coating.

The *Settings* menu includes the following:

- *Measurement parameters*.
- *Connections*.
- *Camera temperature range*.
- *Save options & storage*.
- *Accounts*.
- *Device settings*.

To display the *Settings* menu, tap the *Settings* button .

## 14.1 *Measurement parameters*

For accurate temperature measurements, it is important to use appropriate measurement parameters. The *Measurement parameters* submenu is used to set these parameters. For more information, see section 8.4 *Changing the measurement parameters*, page 15.

## 14.2 *Connections*

- *Wi-Fi*: This setting defines Wi-Fi networks. For more information, see section 10.1 *Connecting to Wi-Fi*, page 20.
- *Bluetooth*: This setting defines Bluetooth connectivity. For more information, see section 13.5 *Bluetooth connection*, page 27.

## 14.3 *Camera temperature range*

For accurate temperature measurements, you must change the *Camera temperature range* setting to suit the expected temperature of the object you are inspecting.

The unit (°C or °F) depends on the temperature unit setting, see section 14.6 *Device settings*, page 31.

## 14.4 *Save options & storage*

- *Auto upload*: When this setting is on, new images will automatically be uploaded to your FLIR Ignite account when the camera is connected to the internet.
- *Photo as separate JPEG*: For the *Thermal MSX*, *Thermal*, and *Picture in picture* image modes, a visual image is always saved in the same JPEG file as the thermal image. Enabling this setting saves an extra low-resolution visual image as a separate JPEG file.
- *Add note after saving*: When this setting is on, the note tool will be displayed when an image has been saved.
- *Digital camera*: This setting is used to turn on/off the digital camera. Turning off the digital camera can for example be required in restricted areas and in confidential (e.g. doctor/patient) situations. When the digital camera is off, the images modes *Thermal MSX* and *Picture in picture* are disabled.
- *Delete all saved files...*: This displays a dialog box where you can choose to permanently delete all the saved files from the camera memory or to cancel the delete action.

## 14.5 *Accounts*

The *Accounts* dialog box is used to pair the camera with your FLIR Ignite account. For more information, see section 10 *Uploading images*, page 20.

---

When the camera is paired, the *Accounts* dialog box displays the following information:

- The FLIR Ignite account that the camera is paired with.
- The link to FLIR Ignite: <https://ignite.flir.com>
- The current storage capacity in your FLIR Ignite account.

## 14.6 *Device settings*

- *Language, time & units*: This submenu includes settings for a number of regional parameters:
  - *Language*.
  - *Date & time*.
  - *Distance unit*.
  - *Temperature unit*.
- *Screen brightness*: The screen brightness slider is used to control the brightness of the screen.
 

**Note** You can also control the screen brightness on the swipe-down menu. For more information, see section 6.3.4 *Swipe-down menu*, page 10.
- *Auto power off*: This setting defines the period of inactivity before the camera enters standby mode.
- *Screen rotation*: This setting is used to enable/disable screen rotation. When enabled, the screen rotates 90° clockwise or anti-clockwise depending on how you hold the camera.
- *Show temperature scale*: This setting is used to show/hide the temperature scale.
- *Update*: This dialog box is used to check for updates and install new firmware versions. The camera must be connected to the internet. For more information, see 15 *Updating the camera*, page 32.
- *Enable USB Streaming*: This setting is used to enable/disable USB streaming from the camera.
- *Product improvement program*: This setting is used to help FLIR improve your camera. The camera can send anonymous information to FLIR about how it is used and, when something does not work as intended, notify FLIR about it.
- *Reset options*: This submenu includes the following settings:
  - *Reset default camera mode...*: This setting will affect the image mode, color palette, measurement tools, and measurement parameters. Saved images will not be affected.
  - *Reset device settings to factory default...*: This setting will affect all camera settings, including regional settings, Wi-Fi networks, and pairing with your FLIR Ignite account. Saved images will not be affected. The camera will be restarted and the start-up wizard will appear again.
  - *Reset image counter...*: This setting will reset the numbering of the image filenames. To prevent image files being overwritten, the new counter value will be based on the highest existing filename number in the camera memory.

**Note** When a reset option is selected, a dialog box is displayed with more information. You can choose to execute the reset action or to cancel.
- *Camera information*: This submenu displays information about the camera, regulatory information, and open-source license information. No changes can be made.

To take advantage of our latest camera firmware, it is important that you keep your camera updated.

There are several ways to update the camera:

- When the camera is connected to the internet, the camera automatically searches for firmware updates. Via the *Settings* menu, you can download and install new firmware versions Over-The-Air (OTA) when they become available.
- Connect the camera to a computer with a USB cable and use the FLIR Camera Updater application to update the camera.
- Download an update package and update the camera manually. For more information, go to <https://support.flir.com>.

## 15.1 Update the camera Over-The-Air (OTA)

To install a new firmware version, do the following:

1. Make sure the camera battery is fully charged.
2. Make sure the camera has Wi-Fi enabled and is connected to the internet.
3. Select *Settings* > *Device settings* > *Update*.
4. If an update is available, select *Download* to download the installation package.
5. Select *Install* to start the installation.
6. When the installation is completed, the camera will automatically restart.

## 15.2 Update via USB cable with the FLIR Camera Updater

The FLIR Camera Updater is a Windows application used to update the camera.

To update your camera, you must log in to your FLIR account or sign up for a new account. You must also register the camera.

### 15.2.1 Install the FLIR Camera Updater

1. Go to <https://support.flir.com>. Find the software download area and search for FLIR Camera Updater.
2. Download the FLIR Camera Updater installer package.
3. Start the installation by double-clicking the executable installer file.
4. Follow the instructions in the setup wizard.

### 15.2.2 Connect the camera

1. Connect the camera to the computer, using the USB cable.
2. Turn on the camera.
3. Run the FLIR Camera Updater application.
4. Sign in to your FLIR account or sign up for a new account.
5. The application automatically connects to the camera.
6. If the camera is not registered, select *Product registration* and complete the registration.
7. If a newer firmware version is available, you can select to update the connected camera.

### 15.2.3 Update notifications

The FLIR Camera Updater can send notifications if there is a new update available for your previously connected devices.

The full text of the Declaration of conformity is available at the following internet address:  
<http://support.flir.com/resources/cx>.



---

**Website**

<http://www.flir.com>

**Customer support**

<http://support.flir.com>

**Copyright**

© 2025, FLIR Systems, Inc. All rights reserved worldwide.

**Disclaimer**

Specifications subject to change without further notice. Models and accessories subject to regional market considerations. License procedures may apply. Products described herein may be subject to US Export Regulations. Please refer to [exportquestions@flir.com](mailto:exportquestions@flir.com) with any questions.

Publ. No.: T810664  
Release: AC  
Commit: 107372  
Head: 107372  
Language: en-US  
Modified: 2025-08-27  
Formatted: 2025-08-27