

PRO
SERIES



Empowering you to work smarter

Recovery Unit NR7 User Manual



NAVAC Inc.
www.NavacGlobal.com
Tel/Fax: +1 877 MY-NAVAC
877 696 2822
MADE IN PRC



Failure to follow warnings could result in death or serious injury.

**SAVE THIS MANUAL
FOR FUTURE REFERENCE**

CONTENT

General Safety	1
Operation Manual	3
Specification	4
Control Panel Introduction	5
Parts Diagram	6
Wiring Diagram	7
Operating Instruction	
1). Refrigerant Hoses Exhaust	8
2). Recovery Mode	9
3). Self-purge Mode	10
4). Liquid Push/Pull Mode	11
Trouble Shooting	12

GENERAL SAFETY

Use information

- In order to prolong the life cycle of the recovery unit, please read the manual carefully before using to fully understand the safety, specification as well as operating procedure of the recovery unit.
- Please check the product received is same as you ordered.
Please check the product if there is any damage during transportation.
Contact with local distributor if the above problem is found.
- Please read the manual carefully and use the unit according to the product operating procedures.

Safety indication

Warning

This mark indicates procedures that must be strictly observed to prevent hazards to people.

Notice

This mark indicates procedures must be strictly observed to prevent damage or destruction of the unit.

Matters needing attention

Warning

Only a qualified technician should operate this recovery unit.

Before starting the equipment, make sure that it is well grounded.

If using electrical extension cord, the cord must be in good condition and properly connected and grounded.

Only a qualified electrician can do the wire connection according to the technical standard and circuit diagram.

The power must be cut off and no display in LCD before inspecting or repairing.

If the original power supply cord is damaged, an OEM replacement may be ordered through your NAVAC distributor.

Please take power supply and the capacity of your ammeter and electrical wire.

GENERAL SAFETY

Only authorized refillable refrigerant tanks can be used. The setting of the pressure limiting device shall not be lower than 45 bar(653psi). Do not overfill the recovery tank, maximum at 80% capacity to make sure that there is enough space for liquid expansion. Overfilling of the tank may cause a violent explosion.

Always wear safety goggles and protective gloves while working with refrigerants to protect your skin and eye from hurting by refrigerant gases or liquid.

Do not use this equipment near flammable liquid or gasoline.

A digital scale is needed to prevent overfilling.

Be sure that the place where you are working is thoroughly ventilated.

Notice

Be sure the unit is working under the right power supply.

When using an extension cord it should be minimum 14 AWG and no longer than 25 feet, otherwise it may cause the voltage drop and damage the compressor.

The input pressure of the unit should not exceed 26bar (377.0psi) .

The unit need to be laid in horizontally, otherwise it will lead to unexpected vibration, noise or even abrasion.

Do not expose the equipment to sun or rain.

The ventilation opening of the unit must not be blocked.

If the overload protector pops, reposition it after 5 minutes.

When doing self purging operation, the knob must be turned slowly to "PURGE" to ensure the inlet pressure is less than 5 bar(72.5 psi).

If fluid hammer happens in the recovery, please turn the knob slowly to "SLOW" position and do not let reading pressure drop to zero.

When you select fast model to start work, please monitor output pressure, if the output pressure increase fast to 27bar(391.6 psi), please turn to slow mode slowly and monitor the outlet pressure not exceeding 35bar(507.6 psi).

The equipment is intended for serving air-conditioning and refrigeration systems containing less than 200 lbs of high-pressure refrigerant.

The tank and hose used must comply with the local regulations.

OPERATION MANUAL

1. Connect the power supply, the indicator light is on for 2 seconds and then off, press the button "①" to keep it for more than 0.2 seconds and then release it to start the device; after an interval of more than 0.5s, press the button "①" to keep it for more than 0.2 seconds and then release it to turn off the device, after an interval of more than 2 seconds, press the button "①" to start the device.
2. Do not mix different refrigerants together in one tank, otherwise they could not be separated or used.
3. Before recovering the refrigerant, the tank should achieve the vacuum level: -29.6inHg, for purge non-condensable gases. Each tank was full of nitrogen when it was manufactured in the factory, thus the nitrogen should be evacuated before first use.
4. The knob should be in the "Close" Position before operation. All the valves must be closed, the input and output fittings should be covered with protective caps when the unit is not in operation. The air/ moisture is harmful to the recovery result and will shorten the life span of the unit.
5. A filter drier should always be used and should be replaced regularly. And each type of refrigerant must have its own filter. For the sake of ensuring the normal operation of the unit, please use high quality filter drier specified. A high quality filter drier will help protect machine.
6. Special-caution is needed when recovering from system, and two dry filters are needed.
7. The unit has an Internal High Pressure protector. If the pressure inside the system is above rated shut-off pressure (see specification), compressor will automatically shut off and the HP cutoff shows: To restart the compressor, please lower the internal pressure (Output gauge indicates lower than 35 bar/507.6 PSI), after the HP cutoff blinks, then Press the "START" button to restart the compressor. When high pressure protection initiates, please determine the cause and deal with it before restarting the unit.
 - ① The input valve of the refrigerant tank is closed—opening the valve will help solve the problem.
 - ② The connecting hose between the recovery unit and refrigerant tank is plugged —close all the valves and replace the connecting hose.
 - ③ The temperature of the refrigerant tank is too high, causing high pressure— cool the tank down.
8. The unit is equipped with an O.F.P. socket and can be connected to a cylinder with a full liquid protection output using the O.F.P. connection cable. When the O.F.P. cable is not plugged in, the unit automatically blocks the O.F.P. function.
9. When recovering a large amount of liquid refrigerant, it is recommended to use the "push-pull mode".
10. To ensure that there is no refrigerant in the equipment after recovery, please read the "self-cleaning" operation procedure in this instruction manual carefully. The residual liquid refrigerant in the condenser may expand and cause damage to the components.
11. The low pressure gauge of this equipment indicates the pressure of the compressor inlet in the recovery machine; the high pressure gauge indicates the pressure of the outlet.
12. After using the equipment, please turn the knob back to the "CLOSE" position.

SPECIFICATION

NR7	
Refrigerants	Category III: R-12, R-134a, R-1234YF, R-401C, R-406A, R-500 Category IV: R-22, R-401A, R-401B, R-402B, R-407C, R-407D, R-408A, R-409A, R-502, R-509 Category V: R-143A, R-32, R-402A, R-404A, R-407A, R-407B, R-410A, R-454B, R-507
Power	115V, 60Hz
Motor	Brushless Motor, 1 HP
Motor Speed	3000 RPM
Maximal Current Draw	12A
Compressor	Oil-less, Air-cooled, Piston
High Pressure Protector	38.5 bar
Operating Temperature	32~104°F
Dimensions	12.2"x9.4"x9.6"
Net Weight	20.3 lbs

Flow Rate

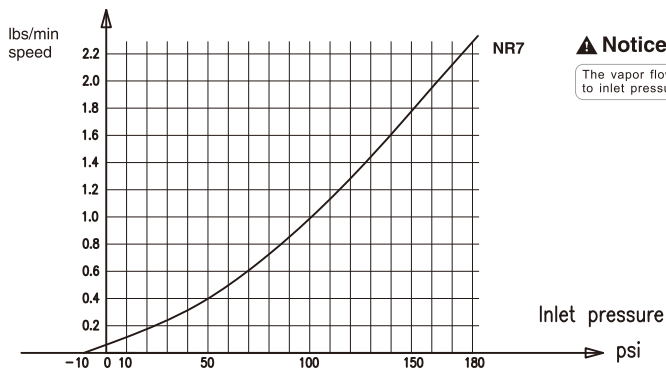

Notice

The vapor flow rate is proportioned to inlet pressure.

CONTROL PANEL INTRODUCTION



Start switch: Starts and stops the unit; press and hold for 0.3 seconds then release to start the unit, press again after 2 seconds to stop the unit.

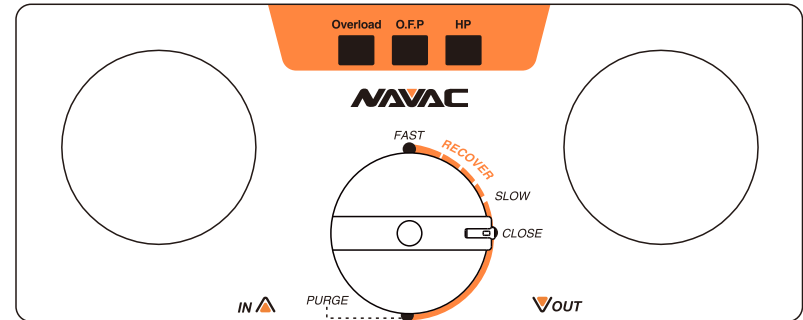

- **Overload:** Overload warning.
- **O.F.P Cutoff:** Will Light up when the recovery cylinder is 80% filled, or if the O.F.P cable is shorted. The machine will stop running.
- **HP Cutoff:** Will Light up when high pressure switch is activated above 560 Psi.
- **Close:** Intake valve closed
- **Recover:** Intake valve partially open
- **FAST:** Inlet valve fully open
- **Purge:** The input valve is closed and the output valve is open, so that the refrigerant in the equipment can be recovered.

PARTS DIAGRAM

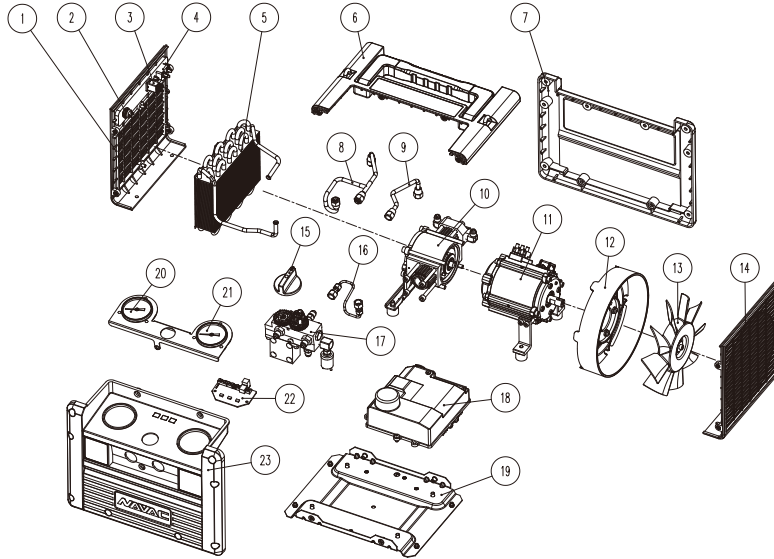

NO.	Parts name	NO.	Parts name
1	Left Side Panel	13	Fan Blade
2	Start Switch	14	Right Side Panel
3	O.F.P Socket	15	Knob
4	Power	16	Pipe
5	Condenser	17	Control Assy
6	Top Panel	18	Motor Control PCB
7	Rear Panel	19	Base
8	Input Pipe	20	Input Gauge
9	Output Pipe	21	Output Gauge
10	Compressor	22	Indicator board
11	Motor	23	Front Side Panel
12	Fan Blade Cover		

WIRING DIAGRAM

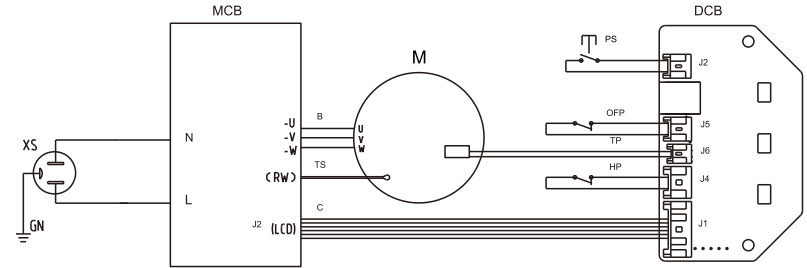

Graphics Code	Item
HS	High pressure sensor
M	Motor
MCB	Motor control board
XS	Socket
DCB	Indicator board
LS	Low pressure sensor
OFF	Over filling protector
TP	Temperature protector
HP	High pressure switch
TS	Temperature sensor
PS	Start/Stop switch
L1	High pressure alarm indicator
L2	Full liquid alarm indicator
L3	Overload alarm indicator

OPERATING INSTRUCTION

1). Refrigerant hoses exhaust

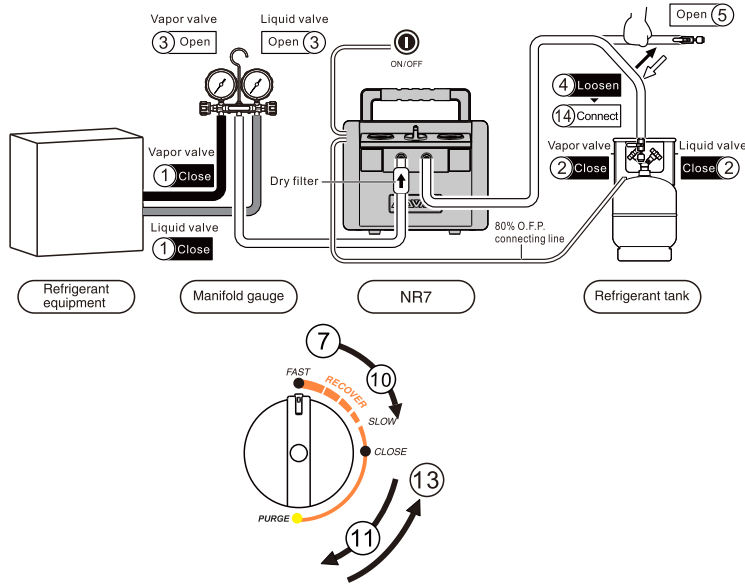
**Ready for operation**

Connect the hoses correctly and firmly. (Please refer to the connection diagram)

1. Confirm the vapor valve and liquid valve of AC system are in close position.
2. Confirm the vapor valve and liquid valve of recovery tank are in close position.
3. Open the vapor and liquid valves of manifold gauge.
4. Loosen the connecting hoses of refrigerant tank.
5. Open the check valve of hoses.

Start operation

6. Plug in the machine, turn on the power.
7. Turn the knob to "Fast".
8. Press "ON/OFF" switch to start the machine, start pumping air inside the hose.

9. Observe the low pressure gauge, the pointer is in the range of "-76cmHg-0" for 30 seconds.
10. Turn the knob to "CLOSE" position, then slowly turn to the "PURGE" position to start purging.
11. Observe the low pressure gauge, the pointer is in the range of "-76cmHg-0" for 30 seconds.

Finish operation

12. Turn the knob to "CLOSE" and stop self purging.
13. Disconnect the refrigerant hose to the tank.

OPERATING INSTRUCTION

2). Recovery mode

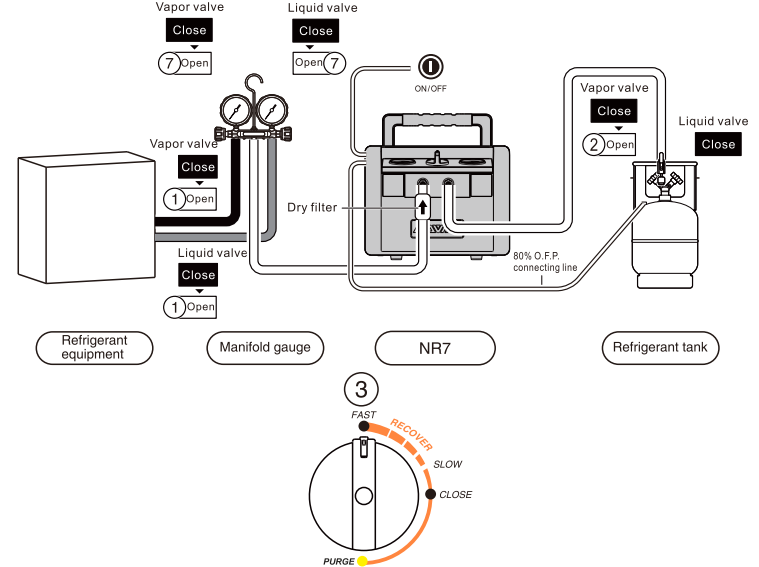
**Ready for operation**

Connect the hoses correctly and firmly. (Please refer to the connection diagram)
Make sure all valves are closed.

1. Open the vapor and liquid valves of refrigerant equipment.
2. Open the vapor valve of the refrigerant tank.
3. Turn the knob to "FAST"
4. Slightly loosen the hose connector connected to the tank to remove the air inside, and then immediately tighten the connector.
5. Open the connection of the corresponding tank (vapor recovery to the liquid port, liquid recovery to the vapor port)
6. Press "ON/OFF" switch to start the machine.
- 7.a. If recover liquid refrigerant, please open the liquid valve of the manifold gauge.

7.b. If recover vapor refrigerant, please open the vapor valve of the manifold gauge.

8. Run to desired vacuum level to finish recovery. Once reached, please turn knob to purge to start the purging process.

▲ Notice

① If fluid hammer happens in the recovery, please turn the knob to "Slow" position slowly, then the reading of low pressure gauge drops until fluid hammer stops; but do not let reading pressure drop to zero, otherwise inlet port is not pumping once at zero pressure.

② If it is difficult to start, turn to "CLOSE" when liquid, turn to "PURGE" when vapor, then press "ON/OFF" to restart the machine, and turn to the required position.

OPERATING INSTRUCTION

3). Purge mode

▲ Notice

The unit must be purged after each use;
Liquid refrigerant remained may expand and damage the components and pollute the environment.

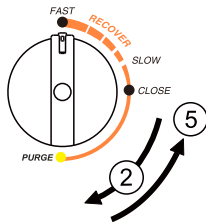
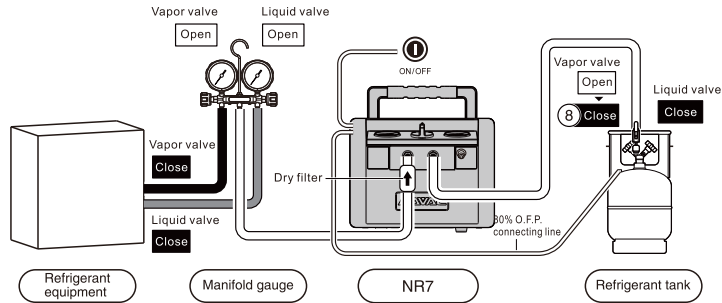

Start operation

1. Run to desired vacuum level to finish recovery.
2. Turn the knob to "Purge" and start purging.
3. The self purging mode will be finished when machine runs to certain vacuum level.

Finish operation

5. Turn the knob to "Close".
6. Turn off the power switch. Disconnect power cord.
7. Close the check valve which connected to exhaust.
8. Close the vapor valve of the tank.
9. Disconnect all hoses.

OPERATING INSTRUCTION

4). Liquid push/pull mode

▲ Notice

An electric scale is needed to monitor the recovery process to prevent overfilling.

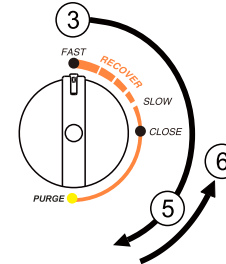
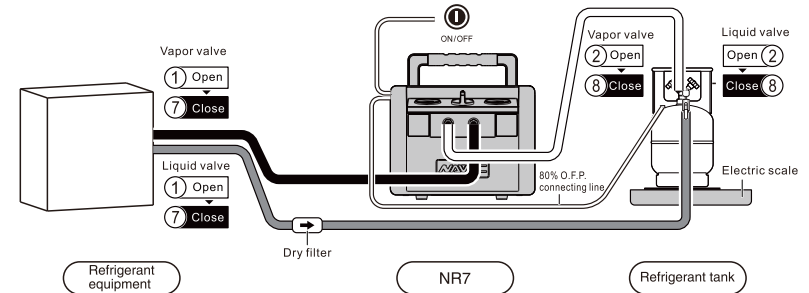

Ready for operation

Connect the hoses correctly and firmly.
(Please refer to the connection diagram)
Make sure all valves are closed.

Exhaust the air in the recovery first: open the recovery machine and loosen the exhaust port, turn the knob to the "FAST" first, and then to the "PURGE" to finish, then turn off the machine.

Start operation

1. Open the vapor valve, liquid valve of the HVAC system.
 - 1.1 Slightly loosen the liquid hose connector at the tank, and tighten the connector quickly after releasing the refrigerant.

2. Slightly loosen the connector of the exhaust pipe at the recovery machine and tighten the connector quickly after releasing the refrigerant.
2. Open the vapor valve, liquid valve of the tank.
3. Turn the knob to "FAST"
4. Press "ON/OFF" button to start machine, then it starts liquid push/pull mode.
5. Turn the knob slowly to "Purge" and start self purging mode for the liquid.
6. Turn the knob to "Close".
7. Close the vapor valve, liquid valve of the HVAC system.
8. Close the vapor valve, liquid valve of the tank.
9. Reconnect the hoses and start recovery mode for the vapor.

