

iDVM 510 True RMS Multimeter and Data Logger



User Manual

November 2017 (English)

© 2015-2017 Redfish Instruments, Inc.

All rights reserved.

Specifications are subject to change without notice.

All product names are trademarks of Redfish Instruments, Inc.

Table of Content

Warranty	04
Registrating iDVM 510 with Redfish Instruments, Inc.	04
Safety Standard, "Warning" and "Caution" Statements	05
Read before Using Meter	06
Instrument Power ON and Setup	07
Meter Function and Terminal Description	08
Display / Symbols	10
Making Basic Measurements	12
Testing and Measuring	13
Understanding AC Zero Input Behavior of True RMS Multimeter	17
Fuse and Test Probe Replacement	18
General Specifications, Product Features	19
Detailed Performance Specifications	20
Use in Environmental Conditions	20
Contact Information Redfish Instruments, Inc.	21

Warranty

The warranty period shall be one year from the date of purchase. This warranty does not cover fuses, disposable batteries, damage from neglect, misuse, contamination, alteration, accident or abnormal conditions of operation or handling, including failures caused by use outside of the product's specifications, or normal wear and tear of mechanical components. This warranty covers the original purchaser only and is not transferable.

For the lifetime of the iDVM 510, Redfish Instruments, Inc. will replace the non functioning components for a fee based on then current component acquisition costs. For the purposes of replacements the life time of the iDVM is not longer than 3 years.

To establish original ownership and prove date of purchase, please register your product on <http://www.redfishinstruments.com> or on the app. Redfish Instruments, Inc. will, at its option, repair at no charge, replace or refund the purchase price of a defective product purchased through a Redfish Instruments, Inc. authorized sales outlet and at the applicable international price. Redfish Instruments, Inc. reserves the right to charge for importation costs of repair/replacement parts if the product purchased in one country is sent for repair elsewhere. If the product is defective, contact your nearest Redfish Instruments authorized service center to obtain return authorization information, then send the product to that service center, with a description of the difficulty, postage and insurance prepaid (FOB Destination). Redfish Instruments, Inc. assumes no risk for damage in transit. Redfish Instruments, Inc. will pay return transportation for product repaired or replaced in-warranty. Before making any non-warranty repair, Redfish Instruments, Inc. will estimate cost and obtain authorization, then provide an invoice for repair and return transportation.

THIS WARRANTY IS YOUR ONLY REMEDY. NO OTHER WARRANTIES, SUCH AS FITNESS FOR A PARTICULAR PURPOSE, ARE EXPRESSED OR IMPLIED. REDFISH INSTRUMENTS, INC. SHALL NOT BE LIABLE FOR ANY SPECIAL, INDIRECT, INCIDENTAL OR CONSEQUENTIAL DAMAGES OR LOSSES, INCLUDING LOSS OF DATA, ARISING FROM ANY CAUSE OR THEORY. AUTHORIZED RESELLERS ARE NOT AUTHORIZED TO EXTEND ANY DIFFERENT WARRANTY ON REDFISH INSTRUMENTS, INC.'s BEHALF. Since some states do not allow the exclusion or limitation of an implied warranty or of incidental or consequential damages, this limitation of liability may not apply to you. If any provision of this warranty is held invalid or unenforceable by a court or other decision-maker of competent jurisdiction, such holding will not affect the validity or enforceability of any other provision.

Registration

After the application connects to your iDVM, the application will ask that the meter be registered. Registration can be completed entirely within the application and is the suggested method of registering. If registration is completed via the application, there is no need to register on the Redfish Instruments website. One or the other is sufficient to register the device, and thus establish ownership and date of purchase

Redfish Instruments, Inc.
info@redfishinstruments.com
1669 Peachwood Dr.
San Jose, CA 95132
831-423-7400

Safety Standard - IEC/EN61010-2

The iDVM 510 meets the safety standards of EN/UL/CSA 61010-1, 61010-2-030, 61010-2-033 for electronic testing instruments. This meter meets CAT III 1000V, CAT IV 600V installations and a pollution degree of 2. This safety standard defines four over voltage categories based on the magnitude of danger from transient impulses. CAT III meters are designed to protect against transients in fixed-equipment installations at the distribution panel including “mains” bus, permanently installed loads, feeders, and branch circuits. While CAT IV meters are designed to protect against transients at “the origin of installation” utility level and outside environments.

Included with the Meter

- iDVM 510
- Test leads
- Battery - not covered by warranty
- Thermocouple
- Magnetic Hanging Strap

Meter Measurements

- AC & DC voltage & current
- Resistance
- Frequency
- Capacitance
- Diode
- Continuity

Warning

“Warning” and “Caution” Statements

A “Warning” identifies hazardous conditions and actions that could cause bodily harm or death.

A “Caution” identifies conditions and actions that could damage the Meter, the equipment under test, or cause permanent loss of data.

Unsafe Voltage

To alert you to the presence of a potentially hazardous voltage, when the Meter detects a voltage overload the OL symbol is displayed.

Test Lead Alert

To remind you to check that the test leads are in the correct terminals, a warning is displayed on the application when you move the rotary switch to or from the mA or A position.

Warning

Attempting to make a measurement with a test lead in an incorrect terminal might blow a fuse, damage the Meter, and cause serious personal injury. Damage to the Meter resulting from this behavior is not covered under warranty. If the equipment is used in a manner not specified by the manufacturer, the protection provided by the equipment may be impaired.

**Warning - Read before using the Meter**

- ▷ Use the Meter only as specified in this manual or the protection provided by the Meter might be impaired.
- ▷ Do not use the Meter or test leads if they appear damaged, or if the Meter is not operating properly. If in doubt, have the Meter serviced.
- ▷ Always use the proper terminals, switch position, and range for measurements.
- ▷ Verify the Meter's operation by measuring a known voltage.
- ▷ Do not apply more than the rated voltage, as marked on the Meter, between the terminals or between any terminal and earth ground.
- ▷ Use caution with voltages above 30 V AC rms, 42 V AC peak, or 60 V DC. These voltages pose a shock hazard.
- ▷ Disconnect circuit power and discharge all high-voltage capacitors before testing resistance, diode function, or continuity.
- ▷ Do not use the Meter around explosive gas or vapor.
- ▷ When using the test leads, keep your fingers behind the finger guards.
- ▷ Do not open Meter enclosure as this will void the warranty.
- ▷ Extended wireless connection to mobile device can cause the battery on the Meter to drain rapidly.

	Important safety information.
	High voltage with danger.
	Ground.
	Double Insulation (Class II safety equipment).
	Fuse must be replaced as per the specification herein.
	AC (Alternating Current)
	DC (Alternating Current)
	AC & DC (Both direct and Alternating Current)
	Accord with the related EU laws and regulations.
	Conforms to UL STD. 61010-1, 61010-2-030 and 61010-2-033; Certified to CSA STD. C22.2, NO. 61010-1, 61010-2-030 and 61010-2-033.
CAT III	It is applicable to test and measuring circuits connected to the distribution part of the building's low-voltage MAINS installation.
CAT IV	It is applicable to test and measuring circuits connected at the source of the building's low-voltage MAINS installation.

Instrument Power ON & Setup

The iDVM 510 is a high resolution professional grade multimeter capable of operating autonomously. Much of the remainder of the manual is dedicated to describing the use of the multimeter in an autonomous fashion.

The most unique feature of the iDVM 510 is its ability to wirelessly connect to a mobile device (iOS or Android). When connected to a mobile device the multimeter can capture and store up to 20,000 data points over an extended period of time. As soon as the meter is turned on via the selector switch, the Bluetooth module advertises its existence for ninety seconds and is available for connection to a mobile device. If the meter has been on for some time, depress the REC/Bluetooth button and the meter will again advertise it's existence for ninety seconds. On the mobile device use your bluetooth settings to find and pair with the iDVM 510. Once paired, connection is permanent until either device is turned off. The meter can be configured to view data as it is acquired, store data, share data via email or dropbox, graph data, measure from a distance and much more. The operation of the "app" is described within the app itself. The help file for the app can also be downloaded from the Redfish Instruments, Inc. website and printed.







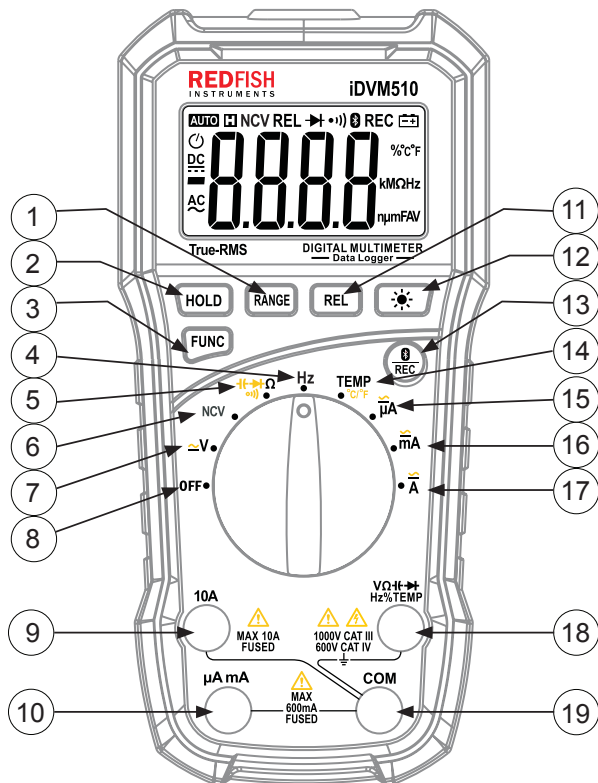







The meter can log data with or without being connected to the mobile device. Depress and hold the REC/Bluetooth button and the meter will begin logging data to internal memory. The meter will use the last logging parameters established in the preceding logging session. Logging parameters are set in the app and described in detail in the app help file. Generally, the user sets two of three parameters: number of data points to be logged, duration of the logging session, or the rate at which the data is acquired. Any two parameters define the third parameter within the context of the meters logging ability. To exit logging mode depress and hold the REC/Bluetooth button or position the selector switch to "off."

The iDVM 510 has sophisticated battery management algorithms including automatic power off (APO), power down during logging, and deep sleep mode to improve battery lifetime. APO can be configured in the app to be on or off as makes sense for the desired purpose. Deep sleep modes and power down during logging is controlled internally and is not available to the user.

Meter Function and Terminal Description









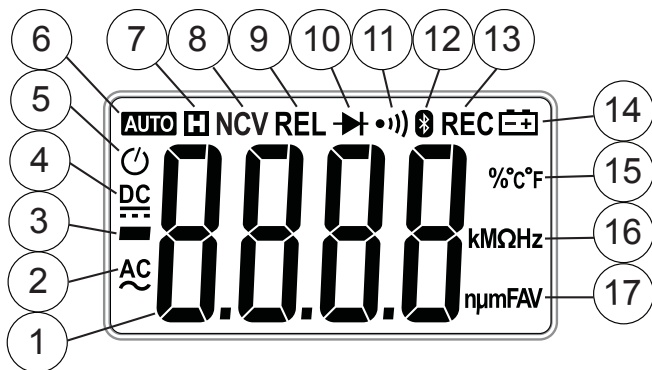









Button Functions

1		Switches between three fixed ranges and auto-range Press and hold switches to auto range
2		Constantly displays the value on the LCD until the HOLD button is depressed again. Holding indicated by "H" on the LCD
3		Toggles between functions shown on the selector switch
4	Hz	With the selector switch pointing to "Hz" the meter measures frequency up to 60MHz
5		Measure capacitance, diode function, resistance and continuity with the selector switch set in this position
6	NCV	Non-Contact Voltage Sensor. With the top of the meter in close proximity to live voltage, an LED will blink & beeper will sound
7		With the selector set to this position, switch between AC & DC voltage measurements using FUNC button
8	OFF	Meter is off - zero current drawn from the battery
9		Probe input for AC or DC serial high current (<10A) measurement
10		Probe input for AC or DC serial low current (<600mA) measurement
11		Permits relative measurements by resetting the zero point
12		Turns on and off the LED back light
13		Single quick press turns on/off BTLE. Single long press turns on/off data logging/recording
14	TEMP °C/°F	Measures temperature. Toggle between F & C using FUNC button
15		Measures micro amps. Toggle between AC & DC using FUNC button
16		Measures milliamps. Toggle between AC & DC using FUNC button
17		Measures amps. Toggle between AC & DC using FUNC button
18		Probe input for volts, resistance, capacitance, diode function, frequency and temperature
19		Probe input for COM return path

Display / Symbols



Button Functions

1		Numeric display and read-out
2		AC measurement
3		Indicates negative value
4		DC measurement
5		Automatic Power Off (APO)
6		Auto range is active
7		Indicates measurement is "holding"
8		Non-Contact Voltage measurement
9		Indicates measurement reading is relative to a previously established zero
10		Diode measurement
11		Continuity measurement
12		Bluetooth (BTLE) is active - either advertising or connected
13		Recording measurements to internal Flash/RAM
14		Low battery indicator - active when battery voltage is < 8.0V
15		Indicates selection of degrees Centigrade or Fahrenheit
16		Indicates magnitude of resistance or frequency measurement
17		Indicates magnitude of voltage or current measurement

Making Basic Measurements

The figures on the following pages show how to make basic measurements. When connecting the test leads to the circuit or device, connect the common (**COM**) test lead before connecting the live lead; when removing the test leads, remove the live lead before removing the common test lead.

Measuring AC and DC Voltage

Measuring Voltage - Volts AC

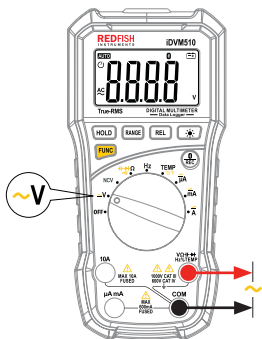

Measuring Voltage - Volts DC

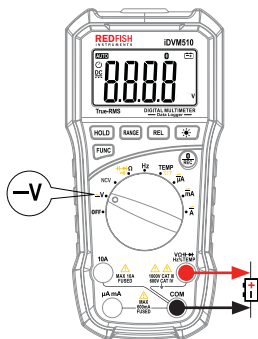

Testing and Measuring

⚠ Warning

To avoid electric shock, injury, or damage to the Meter, disconnect circuit power and discharge all high-voltage capacitors before testing resistance.

Measuring Resistance

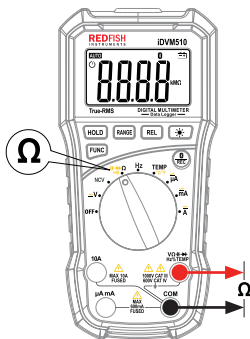

Measuring Continuity

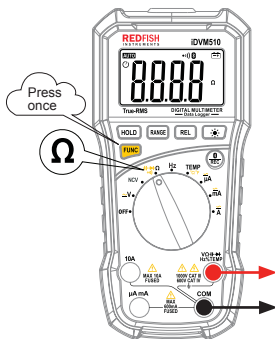

Measuring Diode Function

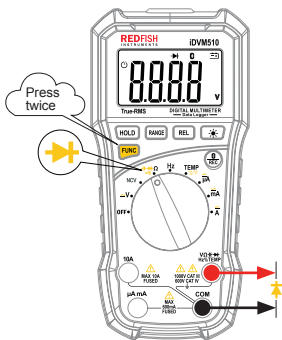

Measuring Capacitance

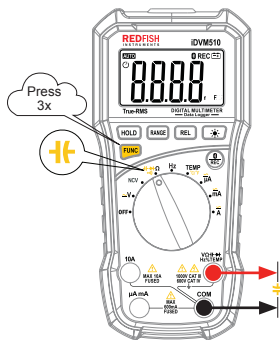

Testing and Measuring

Measuring Non-Contact Voltage (NCV)

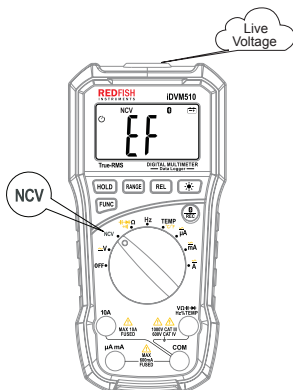

Measuring Frequency

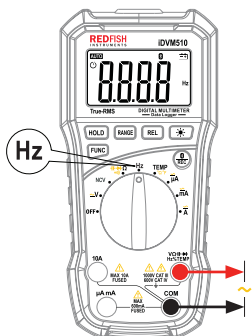

Measuring Temperature C

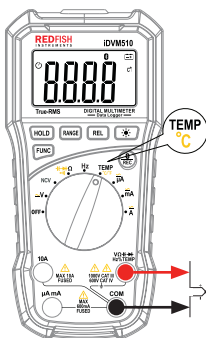

Measuring Temperature F

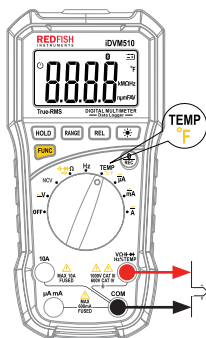

Measuring AC or DC Current

⚠ Warning

To avoid personal injury or damage to the Meter:

- Never attempt to make an in-circuit current measurement when the open-circuit potential to earth is >1000 V.
- Use the proper terminals, switch position, and range for your measurement. use symbol
- Never place the probes in parallel with a circuit or component when the leads are plugged into the current terminals.

Turn power OFF, break circuit, insert Meter in series, turn power on.

Current measurement $\leq 600 \mu\text{A}$

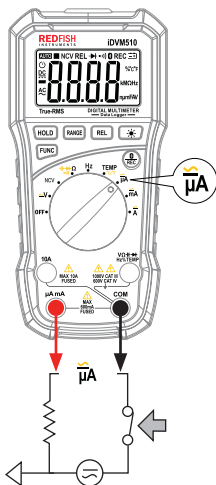

Start with open circuit

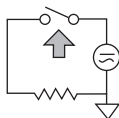

Break the circuit

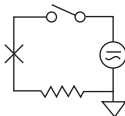

Measuring AC or DC Current

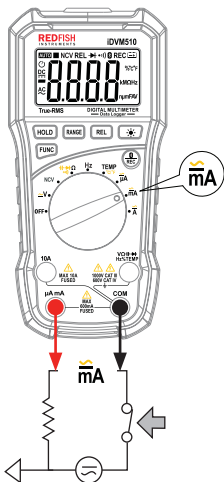

Start with open circuit

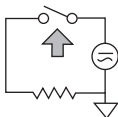

Break the circuit

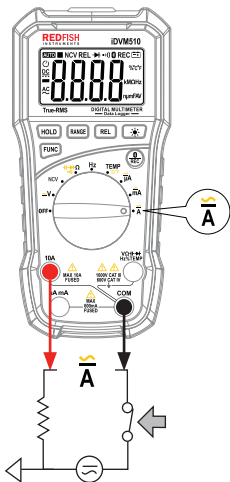
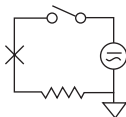

Start with open circuit

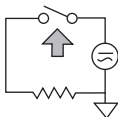

Break the circuit

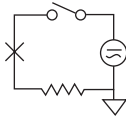

Understanding AC Zero Input Behavior of True RMS Meters

Unlike averaging meters, which can accurately measure only pure sinewaves, True RMS meters accurately measure distorted waveforms. True RMS converters require a certain level of input voltage to make a measurement. This is why AC voltage and current ranges are specified from 5% of range to 100% of range. Non-zero digits that are displayed on a True RMS meter when the test leads are open are normal. They do not affect the specified AC accuracy above 5% of range.

Unspecified input levels on the lowest ranges are:

- AC voltage: below 5% of 600mV
- AC current: below 5% of 600mA

Cleaning

Wipe the case with a damp cloth and mild detergent. Do not use abrasives or solvents. Dirt or moisture in the terminals can affect readings.

Fuse and Test Probe Replacement

- ⚠ WARNING** Fuses are to be replaced by trained service personnel. Fuses are not intended to be replaced by untrained end-users. Return the iDVM to the factory if needed.
- ⚠ WARNING** Fuse replacement by untrained personnel may result in damage to the iDVM or personal injury.
- ⚠ WARNING** Never replace fuses while the iDVM is under load.
- ⚠ WARNING** To avoid electrical shock or personal injury, before opening the battery cover to replace battery, you should turn the meter off and make sure that the test probe is disconnected from the measurement circuit.
- ⚠ WARNING** If the test leads need to be replaced, you must use a new one which should meet EN 61010-031 standard, rated CAT III 1000V, 10A or better.
- To replace fuses, remove the “fuse cover”. This requires that the battery cover be removed by unscrewing the single visible screw on the back of the meter. Once the battery cover is removed the fuse compartment will be revealed. To access the fuse compartment, remove the single screw and remove the fuse cover.
 - Set the iDVM on a solid surface.
 - With an external continuity meter, measure the continuity of each of the fuses.
 - Firmly grasp the fuse that has been blown and remove it from its holder using insulated needle-nose pliers.
 - Grasp the new fuse with the same pliers and place it in its holder.
 - Be sure that the fuse is properly seated.
 - Without an attached load, turn on the iDVM and ensure that the display turns on.
 - Reattach the enclosure, insure that the load is within the meters specification and test the meter.

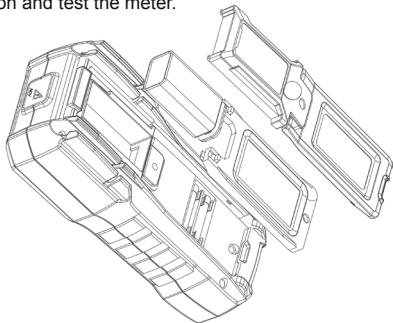

General Specifications

Product Features

Accuracy is specified for 1 year after calibration, at operating temperatures of 18°C to 28°C, with relative humidity at 90%. Accuracy specifications take the form of: plus/minus ([% of Reading] + [Counts]).

- Max voltage must be less than 1000V DC or AC RMS. Surge protection up to 8KV peak per IEC/EN61010. Fuses are 600mA for inputs. <600mA at 1000V and 10A up to 10A at 1000V
- Power supply: DC 9V battery (type: NEDA 1604, 6F22 or 006P.)
- Size is 3.4 inches (W) X 7.0 inches (L) X 2.0 inches (D).
- ⚠ Fuse for 600 mA inputs is <600mA at 1000V fast at 50Ω.
- ⚠ Fuse for 10A input is <10A at 1000V fast at 50Ω.
- Operating temperature is +5 degrees C to +35 degrees C.
- Weight is 405 grams (iDVM only - no probes or packing material).
- Complies with IEC/EN61010 to 600V Overvoltage Cat III and 1000V over voltage Cat IV.
- Certifications are Intertek cETLus, CE and FCC ID: T7VPAN17.
- Pairing with Apple's iOS/Android permits a unique voltmeter user experience.
- User definable data acquisition rate.
- Share data effortlessly via email or DropBox or Google Play.
- App can be downloaded from Apples App Store or Google Play Store.
- Software & Firmware updates pushed through the App Store so that you are always up to date.
- Pinch, Pan, Scroll features familiar to iOS/Android users allow better data visualization & manipulation.
- MIN MAX AVG function is available in the app.
- Auto Ranging and Hold functions are available.
- Data export via standard formats like CSV, SQLite, and graphics files like .PNG or .PDF.
- On-device graphing functions, such as graph colors and scaling are fully customizable.

Detailed Performance Specifications

Specification	iDVM 510 Accuracy
DC Voltage 600mV/6.0V/60V/1000V	+/- 0.5% + 2 counts
AC Voltage 600mV/6.0V/60/1000V	+/-1.0% + 2 counts
DC Current 600 μ A/6000 μ A/60mA/600mA	+/- 0.8% + 2 counts
DC Current 10A	+/- 0.8% + 2 counts
AC Current 600 μ A/6000 μ A/60mA/600mA	+/- 1.2% + 2 counts
AC Current 600 μ A/6000 μ A/60mA/600mA	+/- 3.0% + 2 counts
AC Current 600 μ A/6000 μ A/60mA/600mA	+/- 0.8% + 2 counts
Capacitance 6.0nF/60nF/600nF/60 μ F/600 μ F/60mF/600mF	+/- 4% + 5 counts
Frequency 0-60MHz	+/- 0.3% + 2 counts
Continuity < 50 ohms	+/- 5 ohms

Intended for Use in the Following Environmental Conditions

- Operating environment in which there is no pollution or only dry non-conductive pollution - Pollution degree 2 (two) per IEC/EN61010
- At altitudes up to 2,000 meters
- At temperatures between +5 to +35 degrees C
- At maximum relative humidity of 80% for temperatures up to 31 degrees C decreasing linearly to 50% relative humidity at 35 degree C
- Up to 1000 Volts DC or AC RMS maximum voltage between any terminal with transient over voltages of 8KV peak per IEC/EN61010



Contacting Redfish Instruments, Inc.

call: 1-831-423-7400 in USA.

Visit the Redfish web site at
www.redfishinstruments.com

Register your Meter at
<http://www.redfishinstruments.com/product-registration>
November 2017 (English)

© 2015-2017 Redfish Instruments, Inc.
All rights reserved. Printed in USA.

Specifications are subject to change without notice.
All product names are trademarks of Redfish Instruments, Inc.