

# Flue Gas Analyzer

## DC710



**The Value Leader™**  
[www.tpi-thevalueleader.com](http://www.tpi-thevalueleader.com)

## Contents

<b>Introduction.....</b>	<b>1</b>
<b>General Overview.....</b>	<b>1, 2</b>
<b>Instrument Overview.....</b>	<b>3 ~ 4</b>
<b>Front View.....</b>	<b>3</b>
<b>Back View.....</b>	<b>4</b>
<b>Basic Analyzer Functions.....</b>	<b>5 ~ 6</b>
<b>Turning The Analyzer On &amp; Fuel Selection..</b>	<b>5</b>
<b>Turning The Analyzer Off.....</b>	<b>6</b>
<b>Combustion Analysis Overview.....</b>	<b>7</b>
<b>Combustion Analyzer Mode.....</b>	<b>7 ~ 14</b>
<b>Combustion Test Procedure.....</b>	<b>7 ~ 14</b>
<b>Typical Test Locations.....</b>	<b>9 ~ 11</b>
<b>Typical Test Results.....</b>	<b>14</b>
<b>Specifications.....</b>	<b>15 ~ 16</b>
<b>Calibration &amp; Service.....</b>	<b>17</b>
<b>Warranty.....</b>	<b>17</b>
<b>Appendix A</b>	<b>General Maintenance &amp; Function Tests..... 18 ~ 20</b>
<b>Appendix B</b>	<b>A773 Sulfur Filter Installation &amp; Maintenance. 21 ~ 22</b>
<b>Appendix C</b>	<b>Field Sensor Replacement..... 23 ~ 25</b>
<b>Appendix D</b>	<b>Technical Notes..... 26</b>
<b>Appendix E</b>	<b>Carbon Monoxide Facts..... 27</b>
<b>Appendix F</b>	<b>Carbon Monoxide Limits in Ambient Air Chart.. 28</b>

## Download the TPI View App

Download the TPI View app from the Apple<sup>®</sup> app store or the Google<sup>®</sup> play store to begin using your DC710.



## Introduction

Thank you for purchasing TPI brand products. The TPI DC710 combustion analyzer is state of the art and easy to use. Connect it to your smart device and you are ready to perform combustion analysis. The instrument is ruggedly constructed and comes with a 3 Year unit and 2 Year sensor Guarantee.

Download the TPI View app from the Apple® app store or the Google® play store to begin using your DC710.

## General Overview

The TPI DC710 combustion analyzer uses field replaceable state of the art electrochemical sensors. This sensor technology provides the longest lasting most accurate and reliable means for performing combustion tests. The sensors in your analyzer will need to be replaced periodically and calibration is recommended once every year.

Electrochemical sensors by nature are always active. Therefore the time the analyzer is off and not being used must be taken into account when determining sensor life. The sensors in your analyzer are warranted for two years. This warranty does not cover sensors damaged through misuse of the analyzer.

You should keep the battery of your DC710 charged so power is constantly being supplied to your sensors.

The following guidelines will help prevent damage to your sensors:

- Always use the mini pump filter when testing flue gases.
- Always periodically check and replace the mini pump filter as needed.
- Always make sure the in-line filter / water trap is installed properly.
- Always periodically check and replace the in-line filter as needed.
- Always remove water or condensation from the inside of the in-line filter / water trap assembly prior to performing tests.
- Always use the optional oil filter (p/n A773) when performing tests on oil burning equipment.

## General Overview (Continued)

Never over saturate your sensors by performing tests on equipment with gas levels beyond the capability of your analyzer.

Always keep the A796 water trap / filter assembly clean and replace the filter as necessary. Replacement filter part number is A762F.

This manual will guide you through the functions of the TPI DC710 which will give you many years of reliable service.

Your TPI DC710 Flue Gas Analyzer comes complete with the following standard accessories:

- TPI DC710 Instrument
- Rubber Boot Ends
- Soft Carrying Case (A768)
- Flue Sampling Probe (A770)
- In-Line Filter assembly installed on Flue probe (A796)
- Temperature Probe (GK11M)
- Mini Pump Protection Filter Assembly and spare filters (A763)
- Exhaust Spigot (removable) (A764)
- Instruction Manual

( ) Denotes part number

Your TPI 717 Flue Gas Analyzer has the following options available:

- Spare In-Line Filter (A762F is a package of 5 filters)
- Field replaceable smart CO sensor (A760S)\*
- Field replaceable smart O2 sensor (A761S)\*

\* Factory calibration once per year is recommended

## Instrument Overview - Front View

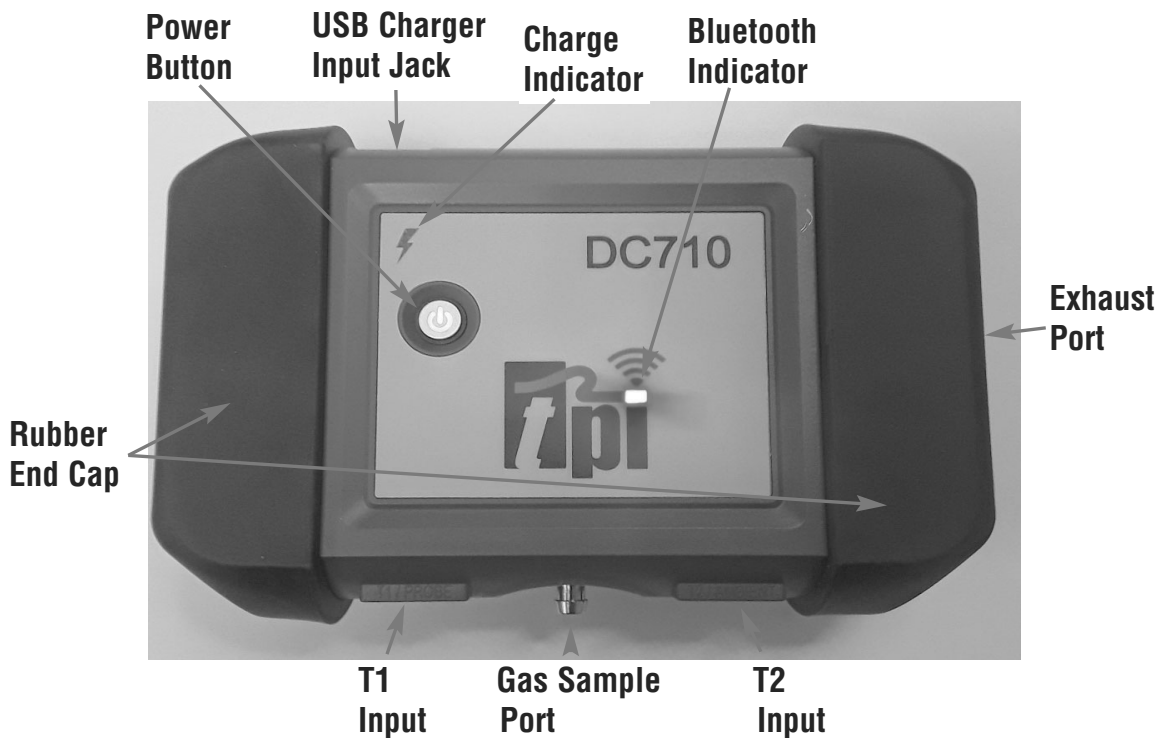

<b>Power Button</b>	Used to turn the DC710 on and off. Illuminates green when power is on.
<b>USB Charger Input Jack</b>	Connection for included charger.
<b>Charge Indicator</b>	Red = Charging. Green = Fully charged.
<b>Bluetooth Indicator</b>	Blue = Connected to smart device. Red = Disconnected from device.
<b>T1 Input Jack</b>	Connection for the flue probe temperature lead (see page 8).
<b>Gas Sampling Port</b>	Connection for Mini Pump Protection Filter and Flue Probe (see page 8).
<b>T2 Input Jack</b>	Connection for ambient temperature probe. If this probe isn't used the DC710 uses its internal temperature sensor (see page 8).
<b>Rubber End Caps</b>	Protects the instrument from accidental damage

## Instrument Overview - Back View

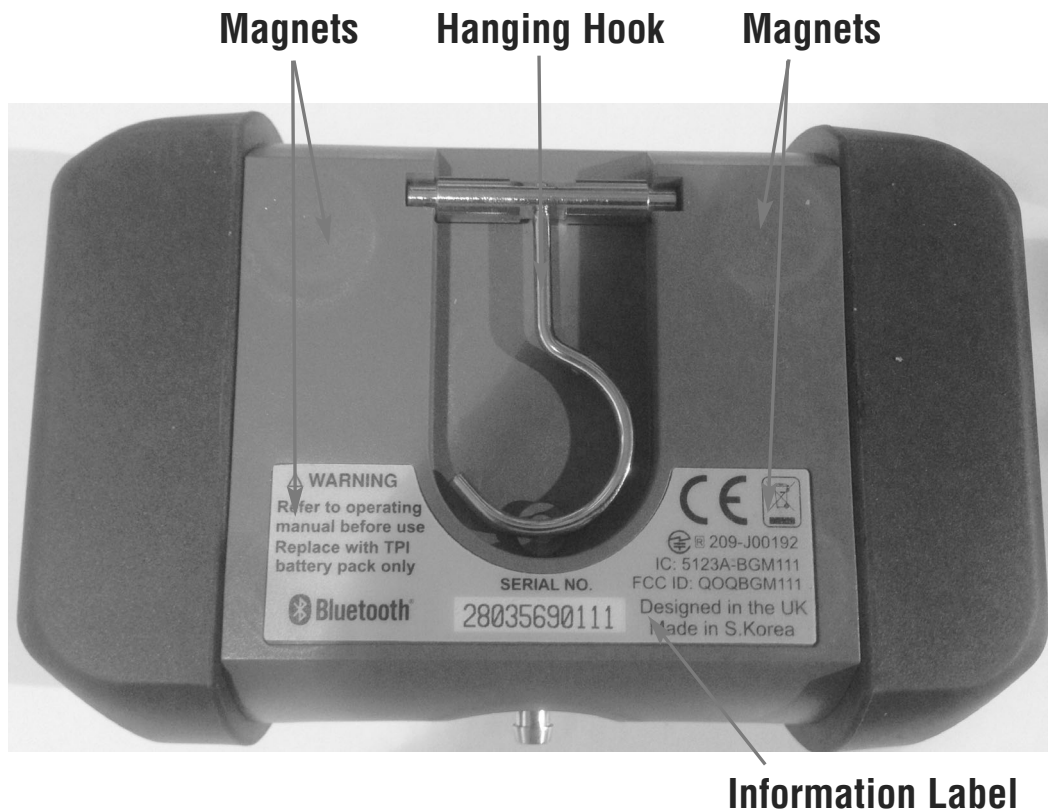

- Magnets:** Used to attach the DC710 to a metallic surface for hands free operation. Note: ensure to surface is not hot or the DC710 may be damaged.
- Hanging Hook:** Used to attach hang the DC710 for hands free operation.
- Information Label:** Contains the serial number and additional information regarding the DC710.

# BASIC ANALYZER FUNCTIONS

## Analyzer Battery

Your combustion analyzer is fitted with a Lithium Ion rechargeable battery. It is important to keep battery power to the sensors in your analyzer even when it is not in use. Your analyzer battery status is indicated at the top right corner of the TPI View App. .

## Turning The Analyzer On & Connecting to the App

**Always: - Before turning on please ensure that nothing is connected to the Gas Sample Port**

Press and hold the power button until the power switch lights on.

Start the TPI View App and tap the center icon to begin scanning for TPI smart instruments.

*Download the TPI View app from the Apple® app store or the Google® play store to begin using your DC710.*



A list of devices will be seen Select the DC710 to connect to by tapping on the desired device.

Once connected the Bluetooth indicator on the DC710 will turn blue and the app will display measurement information.

*After start up, several tests can be performed to ensure proper function of the analyzer and flue probe. Please refer to Appendix A.*

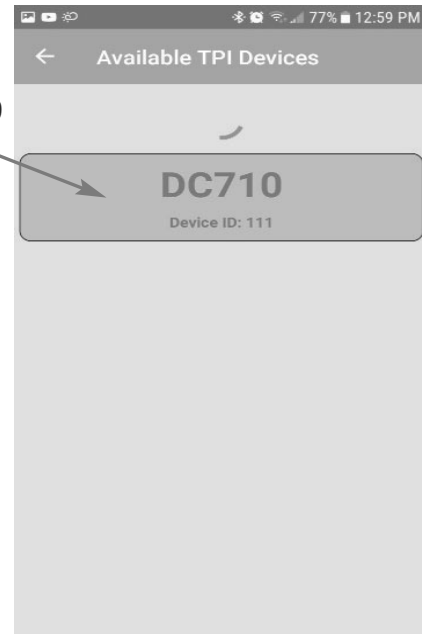

## Turning The Analyzer Off

Always: - Before turning off return the instrument to a clean air environment and allow the Carbon Monoxide level to return to below 10ppm and the Oxygen level to return to 20.9% ( $\pm 0.5\%$ )

If the pump is running tap “Stop Pump” to turn the pump off. If the CO is above 10ppm or the O2 is below 19% the Stop Pump icon will be greyed out. Once the O2 and CO levels are within necessary limits the Stop Pump icon will be active.

Once the pump is off close the app or disconnect from the DC710. Press and hold the power key on the DC710 to turn the analyzer off.

If the app is disconnected before the CO is below 10ppm or the O2 is above 19% and the power key is held down to turn the analyzer off, the pump will continue to run until the CO and O2 are within limits. Once within limits the DC710 will auto power down.

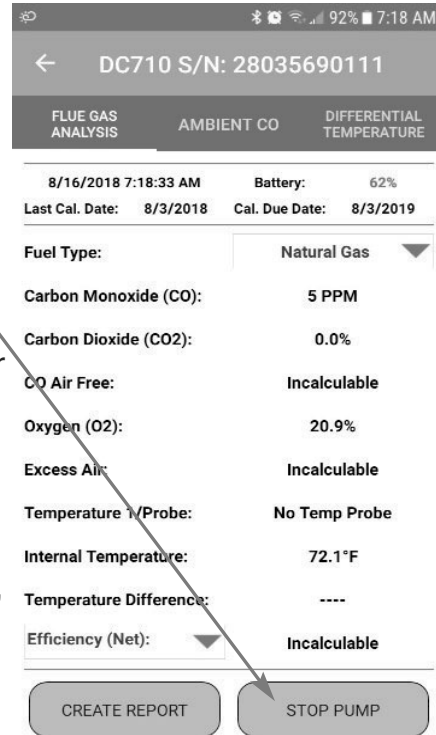



## COMBUSTION ANALYSIS OVERVIEW

Performing combustion analysis is very important to the overall safety and efficiency of heating equipment. The following guidelines and descriptions are generic and meant to provide you with a basic understanding of combustion testing. TPI always recommends you contact the manufacturer of the device under test, obtain information specific to the device, and follow the procedures and safety guidelines for performing tests and affecting repairs.

In general, for most applications, flue gas samples should be taken prior to the draft diverter or any other opening that allows room air to enter the system. This prevents room air from mixing with gases in the flue and diluting the test sample. To ensure accurate and consistent combustion tests, it is important gas and temperature samples be taken at the same location. This is easy with the TPI flue probe because the temperature sensor is an integral part of the probe.

Prior to taking a sample, the device under test should be on and operating. Putting the flue probe in the sample area prior to starting the device may cause saturation of the sensors due to the higher initial concentration of carbon monoxide that may be encountered upon start up. If this happens, allow your analyzer to purge in fresh air until the carbon monoxide level returns to 0 ppm and the oxygen level returns to 20.9%. This may take more than an hour depending on how saturated the sensors are.

The figures on pages 10 through 12 show locations for performing tests on commonly encountered equipment. Remember to consult with the manufacturer of the device under test for specific test information.

Refer to the Appendix D “Technical Notes” for additional information.

## Combustion Test Procedure

*Note: It is recommended you perform routine general maintenance on your analyzer to ensure proper function. Please refer to Appendix A for general maintenance schedule and function tests.*

1. Turn the DC710 on and connect it to the TPI View app as outlined on page 5. Make sure you are in a “clean air” environment (no CO) and tap “Start Pump”.

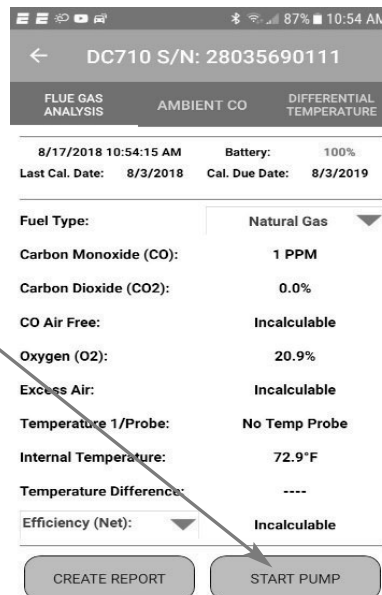

2. Connect the Mini Pump Protection Filter assembly and Flue Probe Tubing complete with In-Line Filter to the Gas Sample Port and the 'K' Type Thermocouple Plug from the Flue Probe into Thermocouple (T1) Socket.

The GK11M ambient air temperature probe is connected to the (T2) socket. If this probe is not used the analyzer will use it's internal temperature sensor for ambient air (T2) reference.

**WARNING:** - Ensure the 'K' type thermocouple probes are inserted into the sockets correctly. The plugs are polarity marked and forcing the plug into the socket the wrong way may result in damage to the instrument.

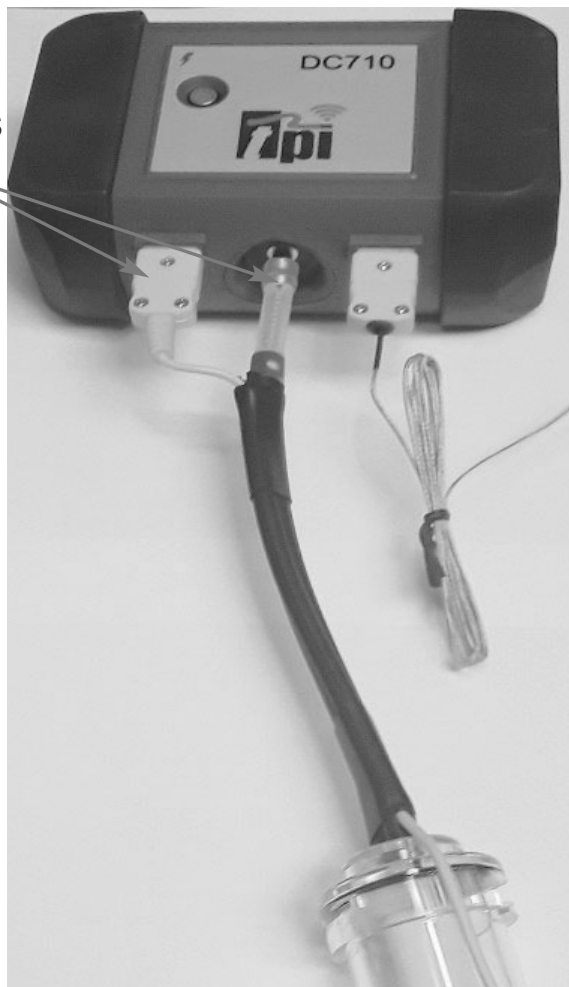

**IMPORTANT:** Prior to taking a sample, the device under test should be on and at operating temperature. **Putting the flue probe in the sample area prior to starting the device may cause saturation of the sensors due to the higher initial concentration of carbon monoxide that may be encountered upon start up.** If this happens, allow your analyzer to purge in fresh air until the carbon monoxide level returns to 0 ppm and the oxygen level returns to 20.9%. This may take more than an hour depending on how saturated the sensors are.

3. Drill a 1/4 inch hole into the flue of the device under test. For most applications, flue gas samples should be taken prior to the draft diverter or any other opening that allows room air to enter the system. This prevents room air from mixing with gases in the flue and diluting the test sample.

***It is important to use manufacturers recommended test locations whenever possible.***

Refer to the figure below for calculating the sample hole location. The figures on the following pages show typical test locations on commonly encountered equipment.

Flue pipe diameter x 1.5 = proper hole location

***Example for a 4 inch flue:***

4 inches x 1.5 = 6 inches

The hole should be drilled 6 inches above the furnace exhaust.

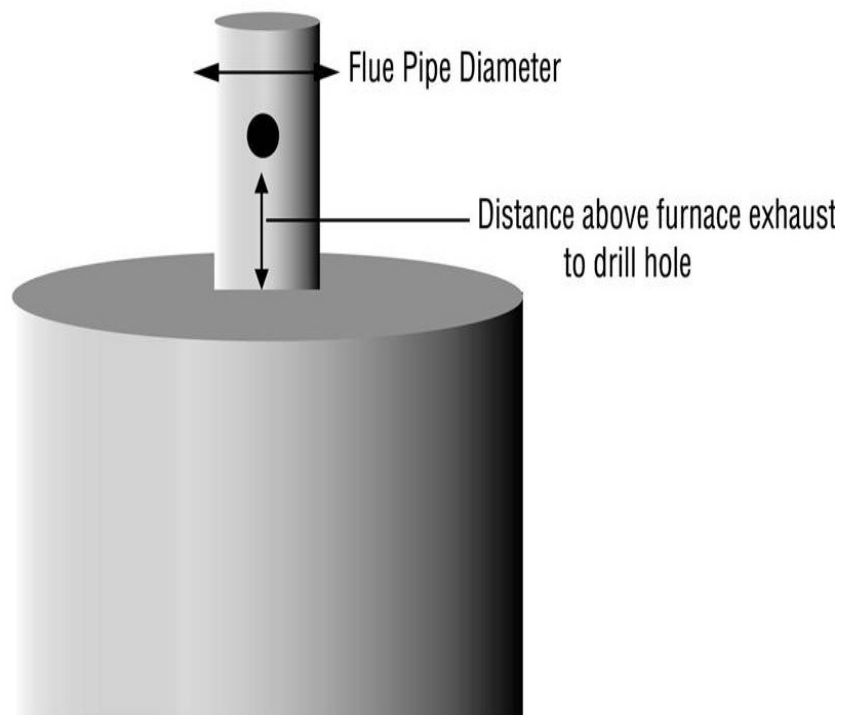

# TYPICAL TEST LOCATIONS

## Atmospheric Gas Fired Fan Assist Boiler / Furnace

### Typical Test Locations

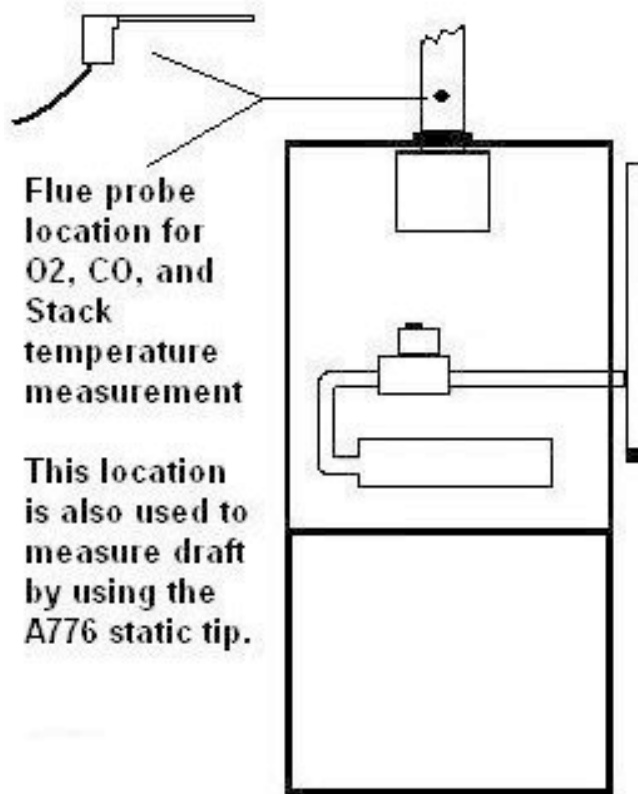

Figure 1

*It is important to use manufacturers recommended test locations whenever possible.*

# TYPICAL TEST LOCATIONS

## Condensing Boiler / Furnace

### Typical Test Locations

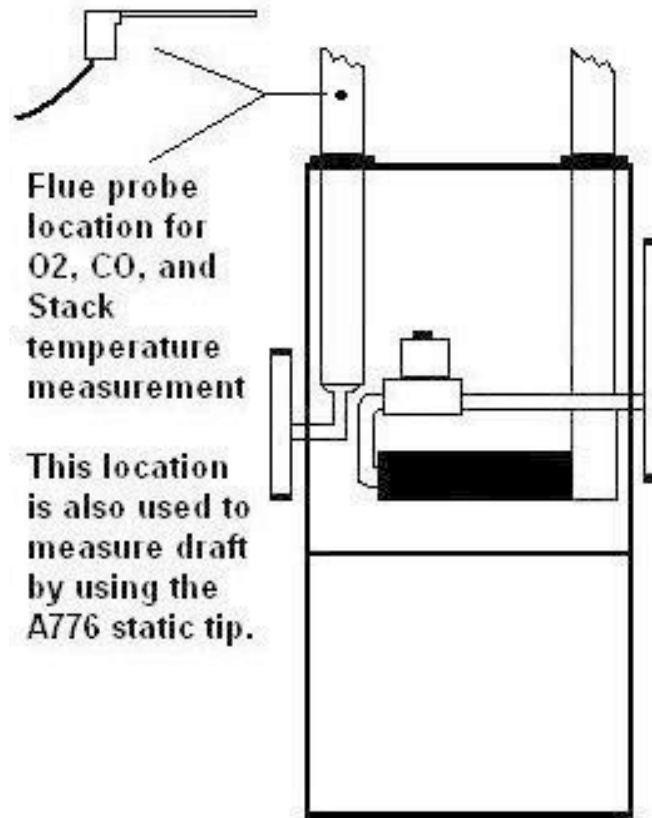

Figure 2

*It is important to use manufacturers recommended test locations whenever possible.*

# TYPICAL TEST LOCATIONS

## Atmospheric Forced Air Furnace

### Typical Test Locations

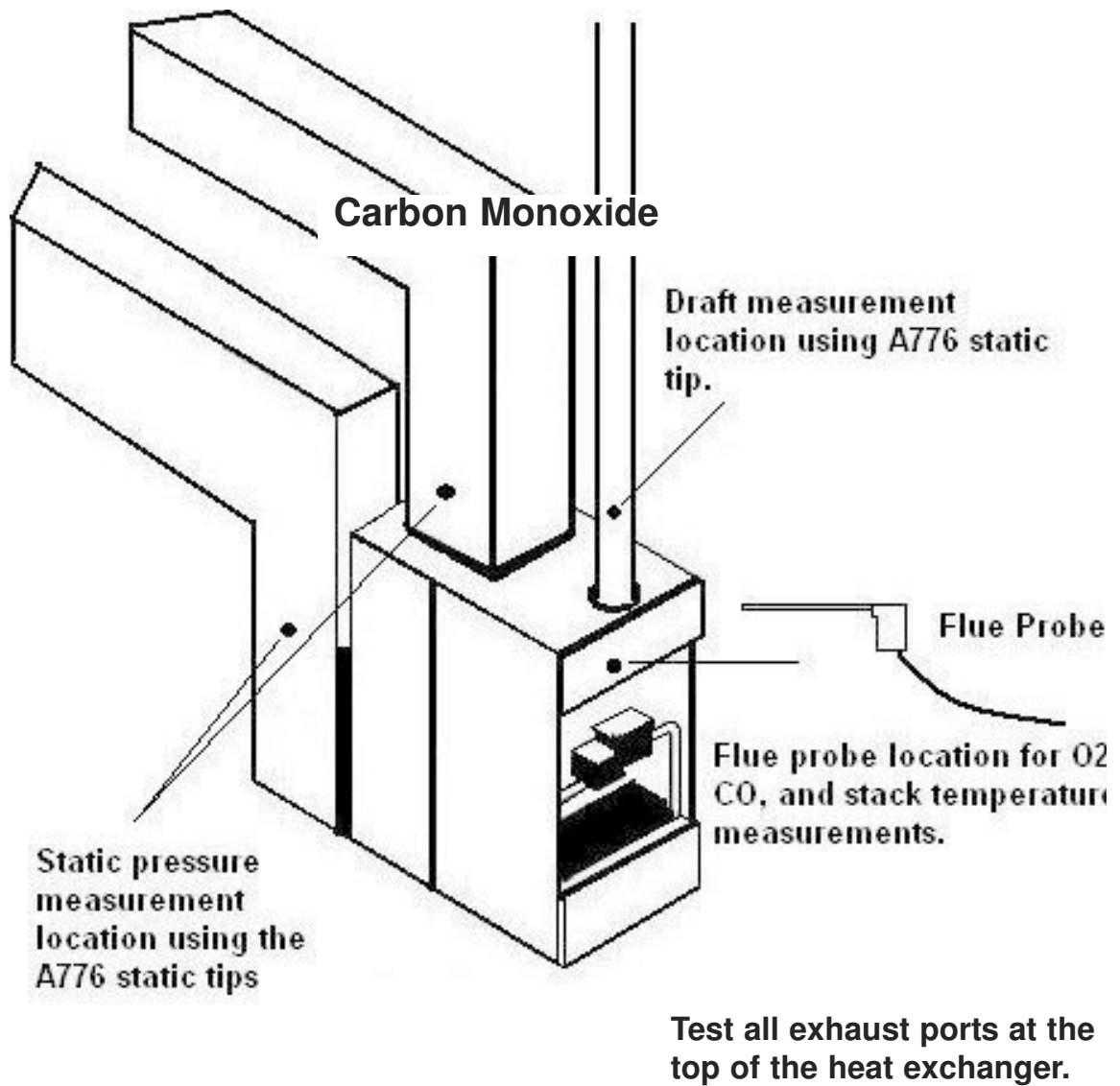

Figure 3

*It is important to use manufacturers recommended test locations whenever possible.*

4. Insert the flue probe into the sample hole of the device under test. The probe tip should be in the middle of the flue pipe or exhaust stream.

Ensure the In-Line Filter / Water Trap hangs below the analyzer in the proper vertical position when readings are being taken. Failure to comply reduces the effectiveness of the water trap and may result in damage to the instrument. Refer to the pictures below for correct and incorrect use.



**WARNING:** - Should the CO reading rise above 2,000ppm the probe should immediately be disconnected from the instrument and the instrument returned to a clean air environment. This ensures the analyzer will not be subjected to an abnormally high concentration of CO, and will protect the sensors.

Make sure to check the water trap periodically during testing to ensure it does not fill with condensate and empty it as necessary. If the filter begins to fill during a test, open the lid and empty out the condensate. After closing the lid, allow readings to stabilize again.

**IMPORTANT:** The water trap is fitted with a water block filter (p/n A794W) in the lid to prevent water from flowing down into the pump. If the water trap fills the water block filter will stop the flow to the analyzer and the pump will slow and no longer pull a sample. The water trap should be emptied immediately if this happens. The water block filter may need to be dried out or replaced before testing can resume.

5. The combustion analysis readings will be displayed on the TPI View app. Allow the readings to stabilize.

The date, time, battery status, last calibration date, and calibration due date are displayed at the top.

The fuel type is selectable by tapping on the down arrow next to the displayed fuel.

Parameter Displayed:

CO Level (measured)

CO2 percentage (calculated)

CO Air Free (calculated)

O2 Level (measured)

Excess Air (calculated)

T1 Temperature (flue temp measured)

Internal Temperature (ambient air measured) or T2 Temperature (measured) if the ambient air probe is connected to T2

Temperature Difference (T1-Ambient)

Efficiency (Calculated)

The efficiency type can be set to Net or Gross by tapping on the down arrow key.

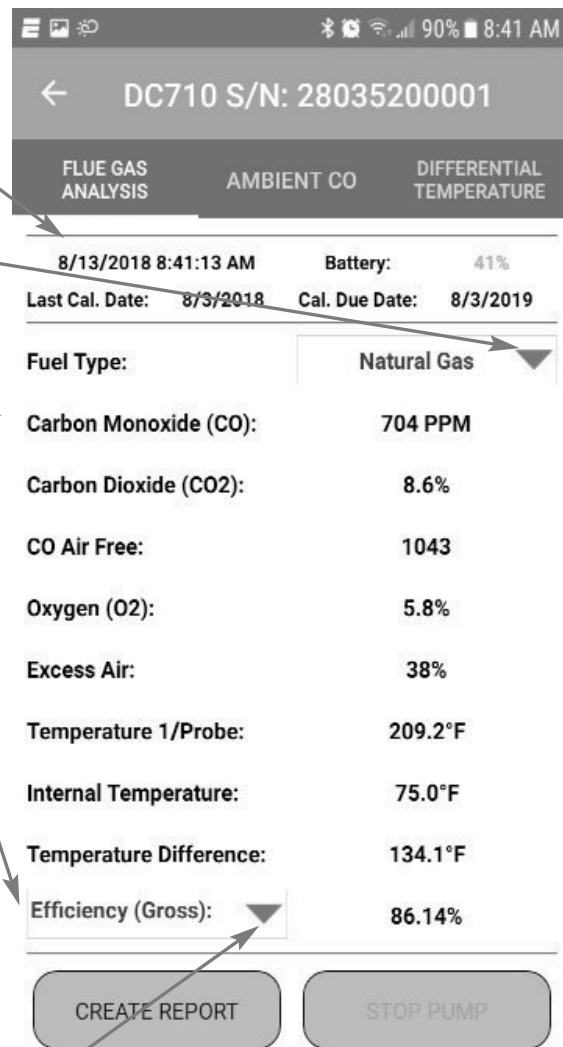

**Note: Gross efficiency is used in the USA.**



6. A report of the test results can be generated and sent via email or printed to the optional A740BT Bluetooth printer.

Tap "Create Report" to start the report generation process.

A box will pop up asking you to enter a report reference. This is like the job name or number of the report.

Once you have entered the desired reference name tap "Set"

DC710 S/N: 28035200001

FLUE GAS ANALYSIS    AMBIENT CO    DIFFERENTIAL TEMPERATURE

8/13/2018 8:41:13 AM    Battery: 41%

Last Cal. Date: 8/3/2018    Cal. Due Date: 8/3/2019

Fuel Type: Natural Gas

Carbon Monoxide (CO): 704 PPM

Carbon Dioxide (CO2): 8.6%

CO Air Free: 1043

Oxygen (O2): 5.8%

Excess Air: 38%

Temperature 1/Probe: 209.2°F

Internal Temperature: 75.0°F

Temperature Difference: 134.1°F

Efficiency (Gross): 86.14%

CREATE REPORT    STOP PUMP

From the report screen you can edit the reference name, email the report to a recipient, and print the report to the optional A740BT Bluetooth printer.

DC710 Report

Reference: Flue Gas Test

**DC710 FGA**

Ref ID: Flue Gas Test

Serial Number: 28035690111

Last Calibration Date: 8/3/2018

Calibration Due Date: 8/3/2019

Date/Time Taken: 8/17/2018 1:24:50 PM

- Flue Gas Analysis Report -

Carbon Monoxide (CO): 1 PPM

Carbon Dioxide (CO2): 0.0 %

CO Air Free: Incalculable

Oxygen (O2): 20.9 %

Excess Air: Incalculable

Temperature 1/Probe: No Temp Probe

Internal Temperature: 74.8°F

Temperature Diff: \_\_\_\_\_

EDIT REF    PRINT

< BACK    EMAIL

# TYPICAL TEST RESULTS

## Power Burners (Gas Fired)

<b>Oxygen</b>	3% to 6%
<b>Carbon Monoxide</b>	Less than 100ppm (air free)
<b>Stack Temperature</b>	300°F to 500°F
<b>Draft</b>	-0.15 inH <sub>2</sub> O

## Power Burners (Oil Fired)

<b>Oxygen</b>	4% to 7%
<b>Carbon Monoxide</b>	Less than 100ppm (air free)
<b>Stack Temperature</b>	325°F to 625°F
<b>Draft</b>	-0.15 inH <sub>2</sub> O

## Gas Fired Burners (Atmospheric / Fan Assist)

<b>Oxygen</b>	7% to 9%
<b>Carbon Monoxide</b>	Less than 100ppm (air free)
<b>Stack Temperature</b>	325°F to 500°F
<b>Draft</b>	-0.15 inH <sub>2</sub> O to -0.4 inH <sub>2</sub> O

# SPECIFICATIONS

## Instrument

Operating Temperature Range	14°F to 122°F (-10°C to 50°C)
Battery Type	Rechargeable Li-ion (3.7V/2600mA)
Battery Life	>6 hours typical
Charger Port	USB Connection
Pre-Programmed Fuels	Natural Gas, LPG, Light Oil, Heavy Oil, Bituminous Coal, Coke, Butane, Wood, Bagasse
Dimensions	150mm x 100mm x 58mm
Weight	490g
Gas Sensor Type	Electrochemical field replaceable smart sensors (O <sub>2</sub> and CO)

## Flue Temperature Probe

Construction	Pistol Grip with Stainless Steel Shaft
Hose Length	2500mm
Insertion Length	200mm
'K' Type Thermocouple Accuracy	+/- 0.3%, +/- 2°F (1°C)
Maximum Temperature	1472°F (800°C)

## Gases

	Range	Resolution	Accuracy
Oxygen	0-25%	0.1%	+/- 0.3%
Carbon Monoxide	0-10,000 ppm	1 ppm	+/- 5 ppm or 5%
			Whichever is greater
Carbon Dioxide	0-25%	0.1%	Calculated
CO/CO <sub>2</sub> Ratio	0-0.999	0.001	Calculated
Combustion Efficiency	0-100%	0.1%	Calculated

# SPECIFICATIONS (Continued)

## Temperature Measurement

Input Type	K-Type thermocouple
Range	-58°F to 1832°F (-50°C to 1000°C)*
Resolution	1°F (1°C)
Accuracy	+/- (0.3% of rdg + 2°F) or +/- (0.3% of rdg + 1°C)

\* The thermocouple supplied (GK11M) has the ability to measure temperatures in the -50°F to 950°F range. The DC710 accepts industry standard K-type thermocouple probes with sub-mini connectors.

## Bluetooth Communication

Bluetooth Version: 4.2

FCC ID: QQQBGM111

IC: 5123A-BGM111

 : 209-J00192



## CALIBRATION & SERVICE

It is recommended that your analyzer be calibrated every 12 months. Please consult Test Products International for further details or send your analyzer to the address below for service.

TPI / Attn. Service  
9615 SW Allen Blvd. Suite 104  
Beaverton, OR 97005

The following are consumable parts for the instrument:

In-Line Filter Element (pkg of 5)	User Replaceable	A762F
Water Block Filter	User Replaceable	A794W
Mini Pump Protection Filter Assem.	User Replaceable	A763
**Oxygen Sensor	User / Factory Replaceable	A761S
**Carbon Monoxide Sensor	User / Factory Replaceable	A760S
<i>**Sensor replacement requires calibration gas.</i>		

Sensors for the DC710 can be replaced in the field. Please see appendix C for the replacement procedure.

**Factory calibration is recommended once per year.**

## WARRANTY

Your TPI DC710 Flue Gas Analyzer is guaranteed free from defects in materials and workmanship for 3 Years from the date of purchase. This guarantee does not affect your statutory rights. For additional information please refer to the included warranty card or contact TPI at 800-368-5719.

To obtain warranty performance or maintenance on your analyzer: - Include with the product your name, address, phone number, written description of the problem and proof of purchase date. Carefully package and return to:

TPI / Attn. Service  
9615 SW Allen Blvd. Suite 104  
Beaverton, OR 97005

## Appendix A: General Maintenance

All combustion analyzers use consumable items such filters and probes. These items are user serviceable and can be taken care of by the operator.

The consumable items that will require operator attention are the water trap / filter assembly, flue probe, pump protection filter, and ambient temperature probe.

The recommended maintenance schedule for your analyzer is as follows:

<b><u>Maintenance Performed</u></b>	<b><u>Frequency</u></b>
Water trap Check	Once per week (Once per day for analyzers that see heavy use or are used in oil fired applications)
Filter Check	
Pump Operation Check	Once per month (More often for analyzers that see heavy use or are used in oil fired applications)
Flue Probe Integrity Check	
Thermocouple Probe Check	

### **Water Trap Check**

Visually check the water trap for:

1. Cracks in the bowl.
2. Broken ears on the bowl where the lid locks on.
3. Broken ears on the lid.
4. Worn out o-ring on the lid.
5. Loose connection to the flue probe tubing.

### **Filter Check**

Signs of dirty or water saturated filters are a slow pump, flow error displayed when the flue probe is connected, and measurements that take longer than normal.

TPI analyzers use three filters to protect the pump and sensors. The first filter to check is the A763 mini pump protection filter. (see picture below)

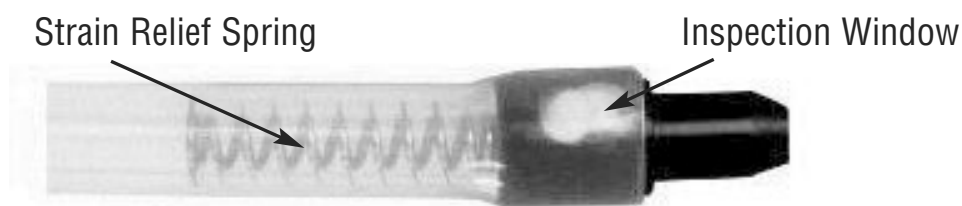

A763 Pump Protection Filter

Look in the inspection window to check the filter. When the filter material becomes dark, pull the black nose cone out of the tubing and replace the ball filter inside.

## Appendix A: General Maintenance (continued)

### Filter Check Continued

The other two filters are located in the water trap (p/n A796). The main filter is the A762F particle filter. This filter stops debris and dust from traveling down to the analyzer. The secondary filter is the A794W water block filter. This filter stops flow in the event the water trap fills with condensate. Refer to the picture below.

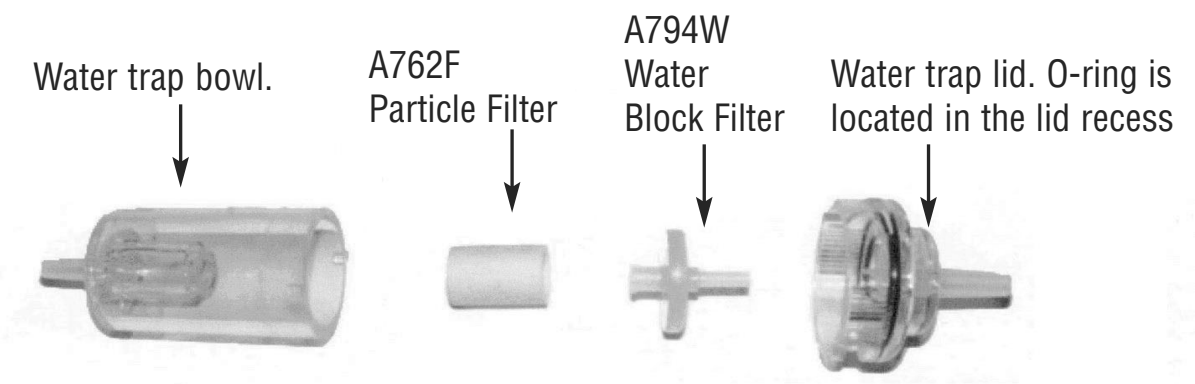

Exploded View of A796 Water Trap

Visually inspect the A762F particle filter. If the filter is discolored on the inside or outside a replacement filter should be installed.

If the A762F is clean but saturated with water a replacement should be installed to ensure proper flow. The saturated filter can be left to dry and reused later.

### Pump Operation Check

1. Turn the analyzer on as outlined on page 5 and connect to the TPI View app. Do not connect anything to the inlet. Turn the pump on by tapping “Start Pump” prior to proceeding to step 2.
2. Cover the analyzer inlet with your finger. The analyzer pump should draw down and begin to slow.

If the analyzer pump does not draw down and slow this may be an indication the pump is faulty, or there is an internal leak. The analyzer should be returned for factory service.

## Appendix A: General Maintenance (continued)

### Flue Probe Integrity Check

NOTE: Perform this check after performing the Pump Operation Check outlined on the previous page.

1. Turn the analyzer on as outlined on page 5 and connect to the TPI View app. Do not connect anything to the inlet. Turn the pump on by tapping “Start Pump” prior to proceeding to step 2.
2. Connect the A763 mini pump protection filter and flue probe assembly to the inlet of the analyzer and the yellow thermocouple connector to input T1.
3. Look at the displayed temperature for T1 on the app. If the displayed temperature is approximately the ambient temperature the thermocouple is operating properly and you may proceed to the next step to continue the test. If the displayed temperature is “No Temp Probe” the thermocouple is open and the probe is in need of factory service.
4. Cover the end of the flue probe with a small piece of tube and pinch the end close. After a short period of time the analyzer pump should draw down and begin to labor. If this happens the flue probe is operating properly and the integrity test is complete. If the analyzer pump does not draw down and labor this is an indication of a possible leak somewhere in the flue probe and you may proceed to the next step for further tests.
5. Pinch the hose below the handle of the flue probe. If the analyzer pump draws down and labors there is a leak in the handle assembly and the probe needs to be factory serviced. If the analyzer pump does not draw down and labor proceed to the next step for further tests.
6. Pinch the hose between the analyzer and the water trap. If the pump does not slow down and labor there may be an internal leak, pump problem, or other issue and the analyzer needs to be factory serviced. If the pump does slow down and labor there is a leak in the water trap assembly and the water trap assembly should be checked as outlined on page 21.



## Appendix B: A773 SULFUR FILTER INSTALLATION & MAINTENANCE

When performing combustion tests on oil fired equipment it is important to use the optional A773 sulfur filter. Failure to do so can result in incorrect and readings. This filter also protects the sensors from the affects of sulfur. The A773 does not have to be removed when working with other types of fuels.

### PROCEDURE

1. Begin with the water trap section of the flue probe oriented as shown in the picture below.

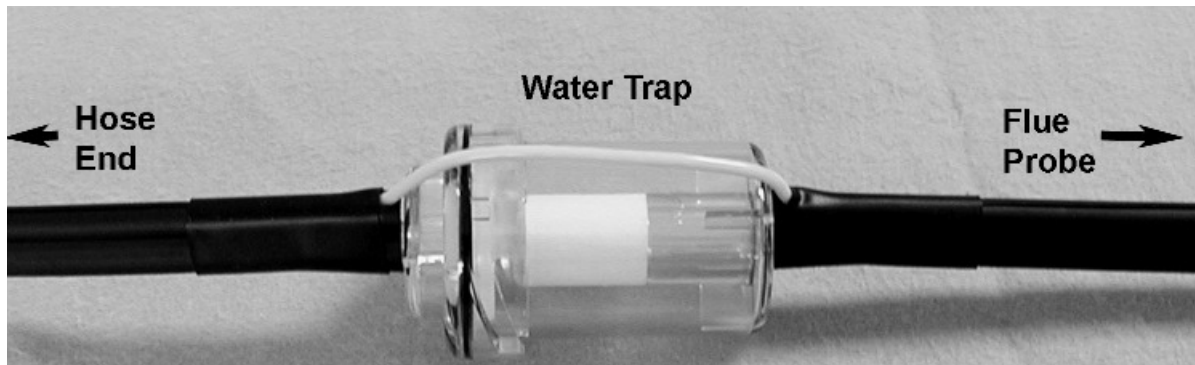

2. Remove the water trap from the flue probe hose. (See picture below)

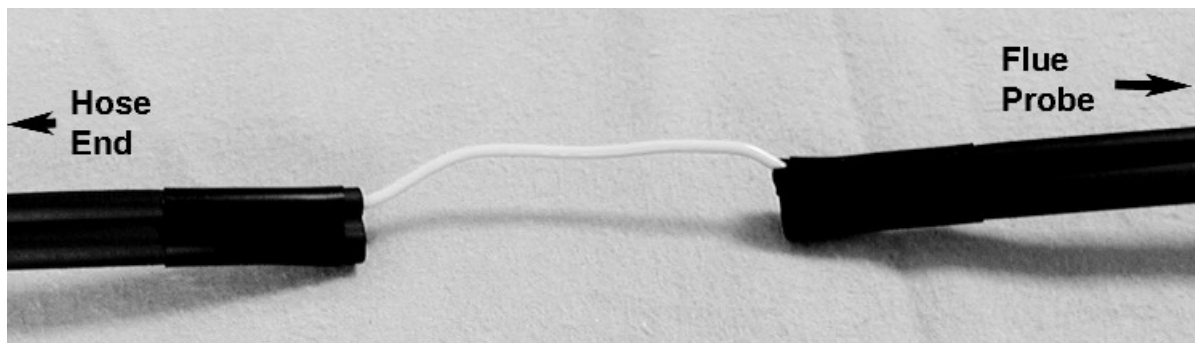

3. Insert the A773 sulfur filter flue probe tube where the water trap was removed.



## Appendix B: A773 SULFUR FILTER INSTALLATION & MAINTENANCE

4. Beginning on the “Flue Probe” side of the A773 sulfur filter, pull the yellow thermocouple cord out of the channel of the flue probe tube. Pull out approximately the length of the water trap that was removed.
5. Being careful not to cut the yellow cord, cut out a section of the flue probe tubing the length of the water trap on the “Flue Probe” side of the A773 sulfur filter. (See picture below)

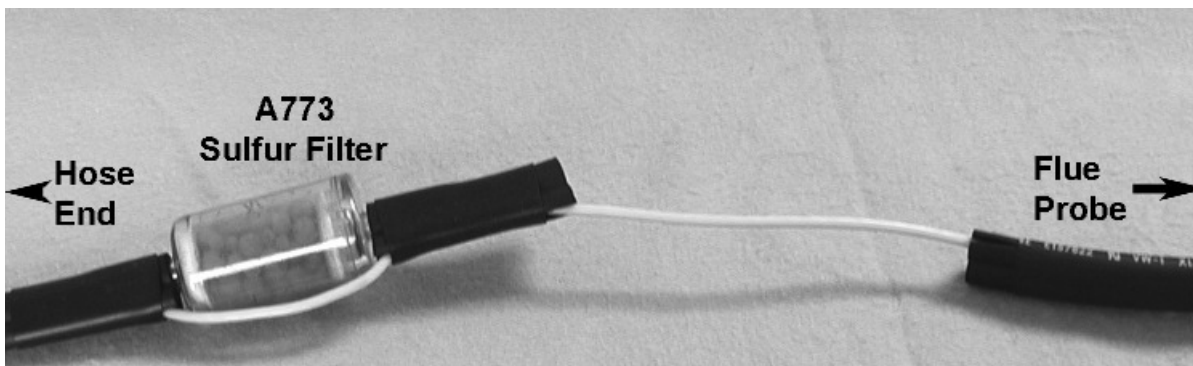

6. Install the water trap in the flue probe hose where the piece was cut out. Make sure the water trap is positioned correctly. The water trap lid should face the “Hose End” side of the hose.

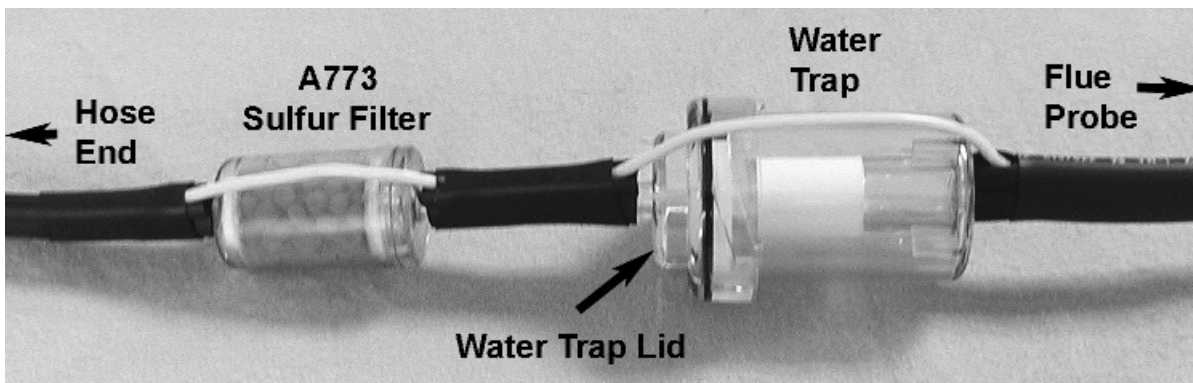

### A773 SULFUR FILTER MAINTENANCE:

The A773 should be replaced when most of the pellets become discolored, usually white or black.

If the A773 begins to trap condensate and fill with water but the pellets are not discolored to the point replacement is required, it should be removed and allowed to dry. Once it is dry it can be reused.

## Appendix C: Field Sensor Replacement

The DC710 uses field replaceable smart sensors. When you receive a sensor it will come pre-calibrated. **Factory calibration once per year is still important to ensure your analyzer is functioning properly on all functions and ranges.**

Contact your TPI distributor to purchase replacement sensors.

*Note: You must wait 24 hours after sensor replacement before using your analyzer.*

Follow these steps to replace the sensors:

1. Remove the protective rubber end caps using your hands to pry them from both ends of the analyzer. .
2. Locate the four screws holding the housing together. (see picture below)



3. Loosen the screw and remove the back housing by separating it from the front housing.

## Appendix C: Field Sensor Replacement (continued)

- Once the back housing is removed you will have full access to the CO and O<sub>2</sub> sensors. (see picture below)

Oxygen (O<sub>2</sub>)  
sensor  
  
Sensor color is  
white.

Carbon Monoxide  
(CO) sensor  
  
Sensor color is  
red.

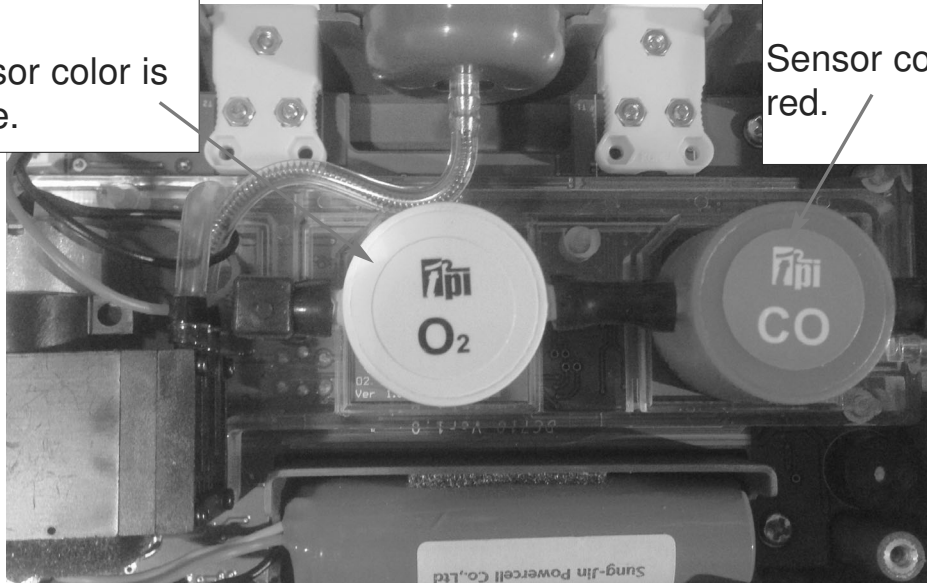

- To remove a sensor, pull the rubber hose off each side of the sensor. (see below)

Hoses removed from smart sensor.

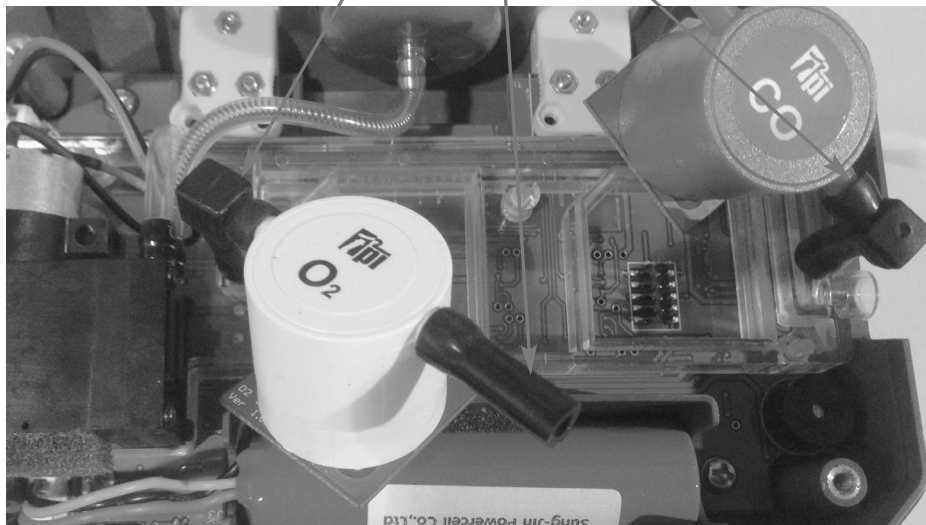

## Appendix C: Field Sensor Replacement (continued)

6. Once the hoses are off the sensor, pull the sensor straight out of the holder (see below).

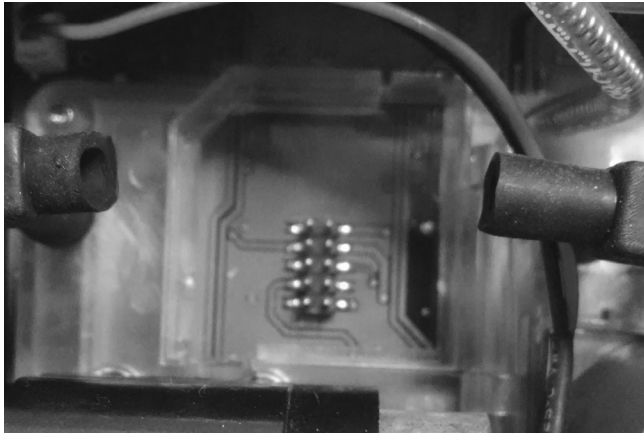

Sensor connector after removal



Smart Sensor

7. Install the new sensor into the holder by orienting the flat corner of the sensor with the flat corner of the sensor holder. Align the socket of the sensor with the pins on the main board and press the sensor down onto the pins and into the holder.

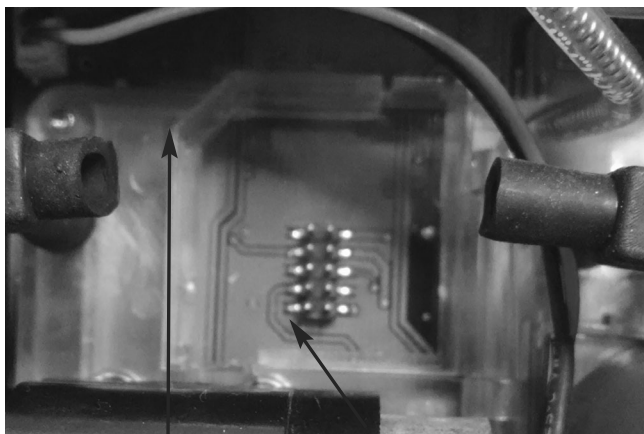

Flat corner of the sensor holder.

Pins on main board.



Flat corner on sensor.

## Appendix C: Field Sensor Replacement (continued)

8. Connect the hoses to the sensor. (see picture below)

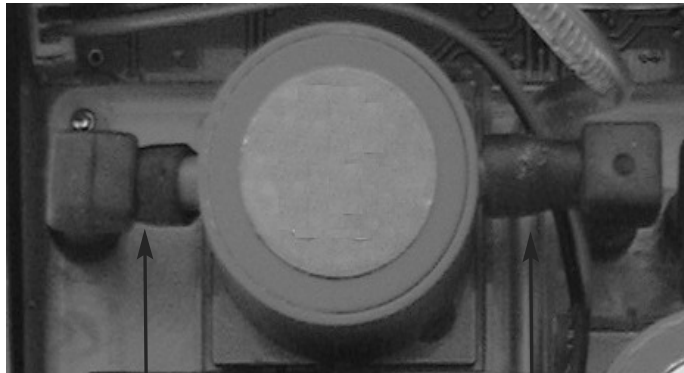

Hoses connected to smart sensor.

9. Repeat steps 5 through 8 for the remaining sensor.
10. Install the back panel onto the front panel and tighten the four screws. Reattach the rubber end caps by pressing them on. Note that one cap has a hole in it and must line up with the exhaust hole on the side of the DC710.
11. Wait 24 hours prior to starting the analyzer. Make sure battery is charged or leave the DC710 on the charger so the sensors are under power. During this time the sensor calibration data will be transferred and the sensor will have power applied to enable it to acclimate.

**NOTE: YOU MUST WAIT 24 HOURS AFTER SENSOR INSTALLATION BEFORE TURNING YOUR ANALYZER ON AND USING IT FOR THE FIRST TIME. FAILURE TO DO SO WILL RESULT IN AN ERROR CODE DISPLAYED AND THE ANALYZER WILL NOT FUNCTION PROPERLY.**

**NOTE: FACTORY CALIBRATION ONCE PER YEAR IS STILL RECOMMENDED TO ENSURE PROPER OPERATION AND ACCURACY OF ALL FUNCTIONS AND RANGES.**

## Appendix D: Technical Notes

**Note 1:** Several factors affect combustion efficiency. Dirty or clogged air filters reduce the amount of air available for combustion therefore reducing efficiency. Obstructions in the flue block exhaust gases and alter the air mixture in the combustion chamber which reduces efficiency. Air leaks in the combustion chamber also alter the mixture causing decreased efficiency.

**Note 2:** The primary way to affect change in combustion efficiency when working with modern gas fired equipment is through gas manifold pressure adjustment. Confirm manifold pressures are within manufacturers specifications prior to performing a combustion test. Once manifold pressures are within limits a combustion test can be performed to provide information regarding any adjustments that may be needed.

**Note 3:** Gross efficiency calculation takes into account wet losses (latent heat) and is the unit of measure used in the USA. Net efficiency only takes into account dry losses (latent heat is not figured in) and is used in Europe.

## Appendix E: CARBON MONOXIDE FACTS

Carbon Monoxide (CO) is invisible, odorless, and tasteless. It is the byproduct of combustion and levels are elevated when there is incomplete combustion.

Sources of CO include:

- Unvented kerosene and gas space heaters
- Leaking chimneys & furnaces
- Gas water heaters
- Back drafting from furnaces
- Wood stoves & fireplaces
- Gas Stoves
- Automobile exhaust
- Tobacco smoke

Carbon Monoxide is picked up quickly in the body by red blood cells. At high levels of CO the body replaces oxygen with carbon monoxide.

The most common symptoms of CO poisoning are headache, dizziness, weakness, nausea, vomiting, chest pain, and confusion. High levels of CO inhalation can cause loss of consciousness and death. Unless suspected, CO poisoning can be difficult to diagnose because the symptoms mimic other illnesses.

People who are sleeping or intoxicated can die from CO poisoning before ever experiencing symptoms.

Please see the next page for a list of exposure times and symptoms.



## Appendix F: Carbon Monoxide in Ambient Air Chart

This chart contains maximum exposure levels and times for carbon monoxide. This is a general guideline only. It is recommended you check with your local government for guidelines in your area.

Concentration of CO in the air	Toxic Symptoms
9ppm	The maximum allowable concentration for short time exposure in a living area according to ASHRAE.
35ppm	The maximum allowable concentration for continuous exposure in an 8 hour period according to OSHA.
200ppm	Maximum allowable concentration at any time according to OSHA. Slight headache, fatigue, dizziness and nausea after 2 to 3 hours exposure.
400ppm	Frontal headaches and other symptoms intensify after 1 to 2 hours exposure. Life threatening after 3 hours. Maximum allowable limit in flue gas according to EPA and AGA.
800ppm	Headache, dizziness, nausea, and convulsions within 45 minutes of exposure. Unconscious within 2 hours. Death within 2 to 3 hours.
1,600ppm	Headache, dizziness, and nausea within 20 minutes of exposure. Death within 1 hour.
3,200ppm	Headache, dizziness, and nausea within 5 to 10 minutes of exposure. Death within 30 minutes to 1 hour.
6,400ppm	Headache, dizziness, and nausea within 1 to 2 minutes of exposure. Death within 10 to 30 minutes.
12,800ppm	Death within 1 to 3 minutes.

**Notes:**

**Notes:**

**Test Products International, Inc.**

9615 SW Allen Blvd., Ste. 104

Beaverton, OR 97005

Tel: 503-520-9197

[www.testproductsintl.com](http://www.testproductsintl.com)

**Test Products International, Ltd.**

342 Bronte Road South, Unit #6

Milton Ontario Canada L9T 5B7

Tel: 905-693-8558

[www.tpicanada.com](http://www.tpicanada.com)

**Test Products International Europe Ltd.**

Longley House, International Drive

Southgate, Crawley, West Sussex RH10 6AQ

Tel.: +44 (0) 1293 530196

[www.tpieurope.com](http://www.tpieurope.com)